



Grand Garden Chalet

Thank you for purchasing a Grand Garden Chalet. Please take the time to identify all the parts prior to assembly.

Please use Safety Eyewear and Gloves while Assembling. Be sure to read and follow all operating instructions for any tools used during assembly. Remember- NO SAW CUTTING IS REQUIRED!

Safety Points and Other Considerations

Our products are built for use based on proper installation and normal residential use, on level ground.

Please follow the instruction manual when building your Grand Garden Chalet and retain the manual for future maintenance purposes.

Some of the safety and usage measures you may wish to consider include:

-If the product is elevated, any structural and building code requirements are solely the customer's responsibility, and should be abided by.

-In high or gusty wind conditions it is advisable to keep the structure securely grounded.

-Have a regular maintenance plan to ensure screws, doors, roof and parts are tight.

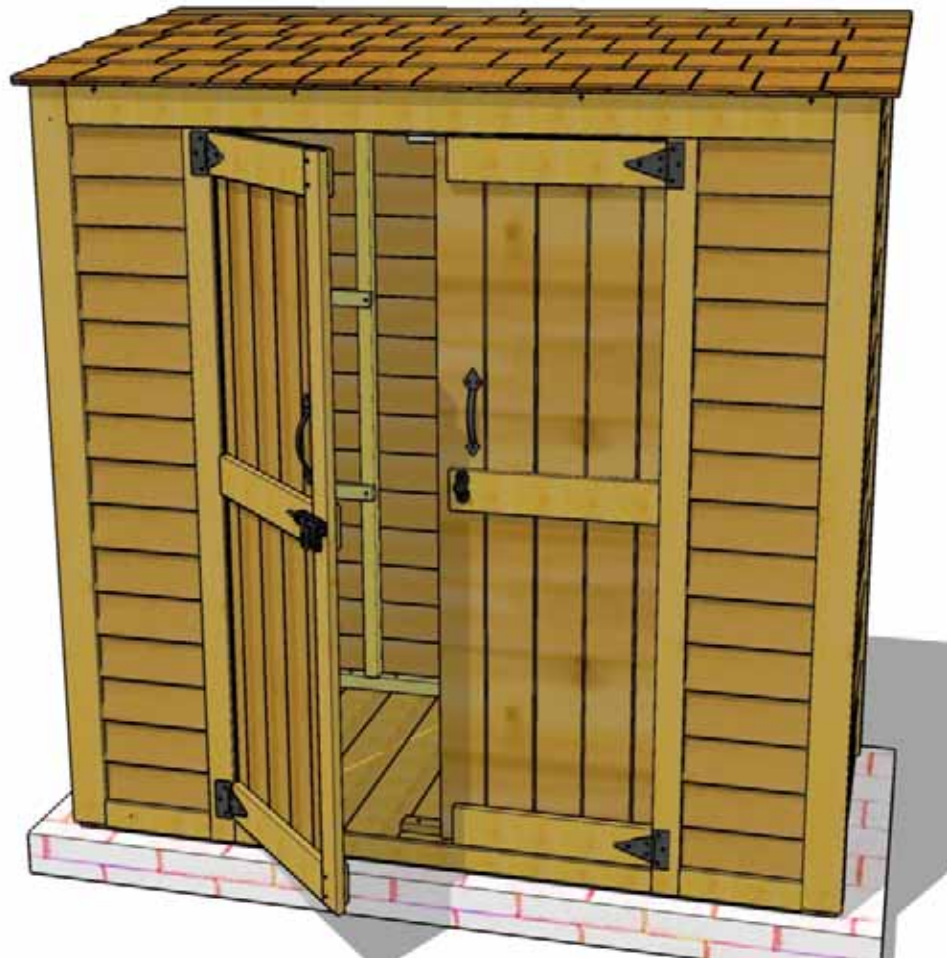

Grand Garden Chalet Dimensions:

Inside - 33" d x 73" w x 70" (back) 65" (front)

Outside with Roof Overhang - 39"d x 78" w x 73"(back) 69" (front)

Outside (Outside Trim to Trim) - 36 1/2"d x 74 1/2" w x 72"(back) 68" (front)

In the event of a missing or broken piece, simply call the '6 YUJW XU Customer Support' @bY' @ 1-, ++!&' &+(&, within 30 days of the delivery of your purchase. It is our commitment to you to courier replacement parts, free of charge, within 10 business days of this notification. Replacement parts will not be provided free of charge after the 30 day grace period.



Note: Our Sheds are shipped as an unfinished product. If exposed to the elements, the Western Red Cedar lumber will weather to a silvery-gray color. If you prefer to keep the cedar lumber looking closer to the original color, we suggest that you treat the wood with a good oil base wood stain. You may also wish to paint your new shed rather than stain it. In both cases we recommend that you consult with a paint and stain dealer in your area for their recommendations.



Congratulations on assembling your 6x3 Grand Garden Chalet!

We hope your experience constructing our **6x3 Grand Garden Chalet** has been both positive and rewarding. We value your feedback and would like to hear back from you on how well we are doing in the following areas:

- 1. Customer Service**
- 2. On Time Shipping**
- 3. Motor Freight Delivery**
- 4. Quality of Materials**
- 5. Assembly Manual**
- 6. Overall Satisfaction.**



Bearicuda Inc.
3 West Street
Litchfield CT 06759

6X3 GRAND GARDEN CHALET

Hardware Kit (Provided)

Note: screws and nails shown actual size.

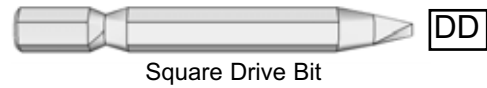
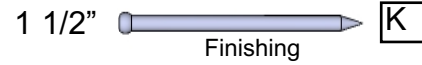

(U) Tee Hinge
x 4 pcs.



(X) Door Handle
x 2 pcs.



(W) Barrel Bolt



(BB) Silver
Barrel Bolt



(4D) 2 1/4"x 2 1/4"
Door Trim Spacer



(UU) 1/2"x 2 3/4"
Plywood Spacer

Tools Required (Not Provided)



Hammer



Screw Gun/Drill



Tape Measure



Wood Clamp



3/8" Wrench



Level



Pliers



Ladder



1/8" & 3/8" Drill Bits

Safety Equipment Required (Not Provided)



Safety Glasses



Work Gloves

1. Lay Chalet Floor Section (1) (35 5/8" x 74 1/4") on a level foundation only. Patio Stones or a Concrete Slab both make excellent foundations. Use a level to confirm and shim floor joists as required.

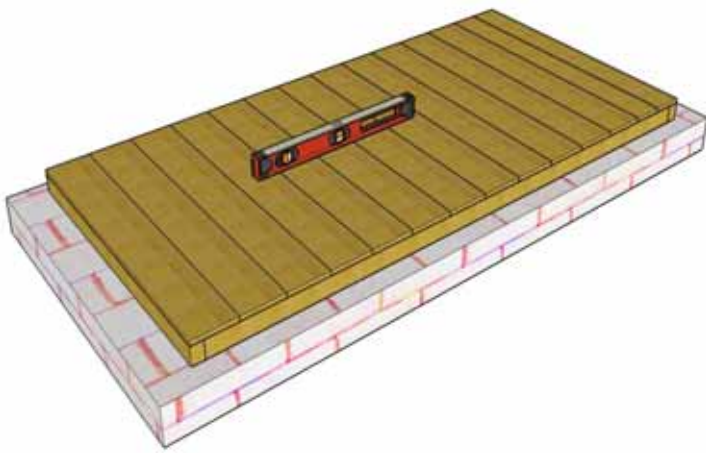

Due to packaging constraints, center wall studs must be attached prior to erecting walls.

2. Locate both Side Wall Panels (2A) (left and right side panels) and 2 Side Wall Studs (2B) (1 1/2" x 1 1/2" x 64 1/2"). Side Wall Studs are angle cut on 1 end. Lay on a flat level surface with frames up. Locate **Back Wall Panels (2C)** and **Back Wall Studs (2D) (1 1/2" x 1 1/2" x 67")**. The top framing of both back walls are angle cut. Lay on flat level surface.

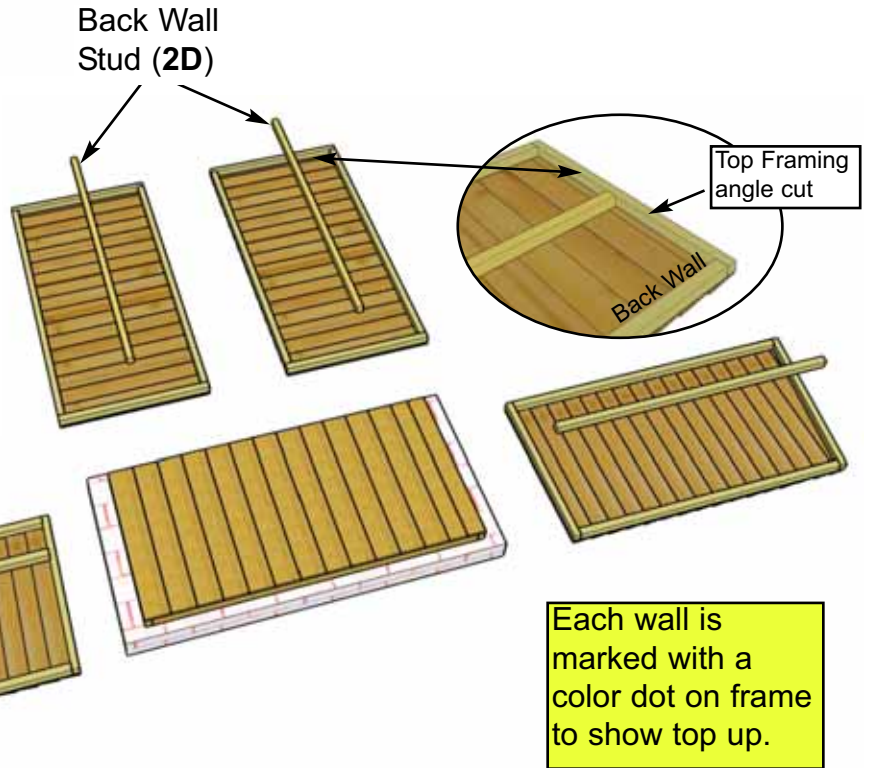

3. Center Studs on each wall and attach with 1 - 2 1/2" Screw (C) per end. Flip walls over.

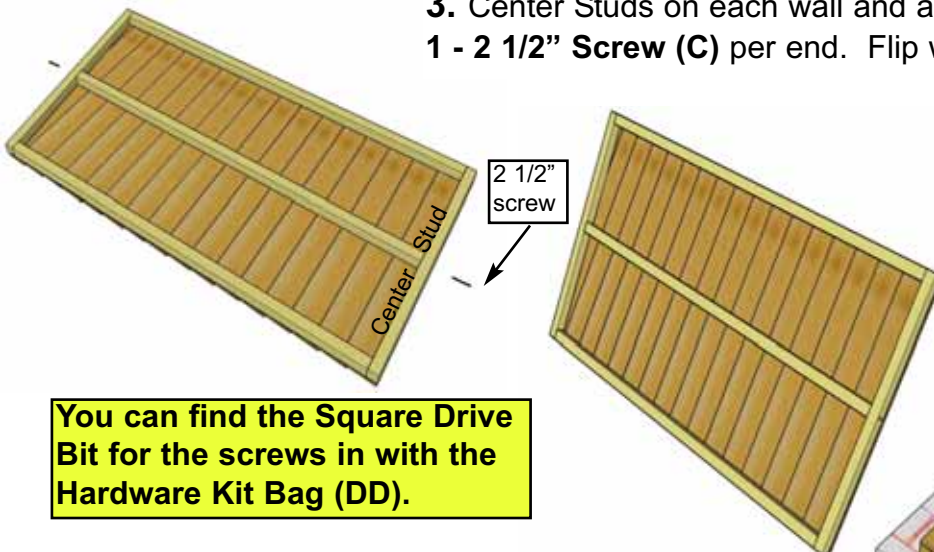

4. Using a tape measure or chalk line as a nailing line, attach wall studs to siding with 1 - 1 1/2" Finishing Nail (K) per piece of siding. Nail into thick part of siding (butt). Skip bottom and top siding pieces. Complete all stud attachments now.

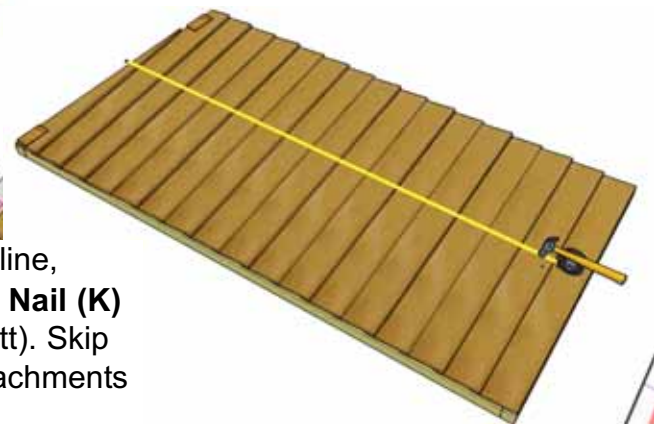

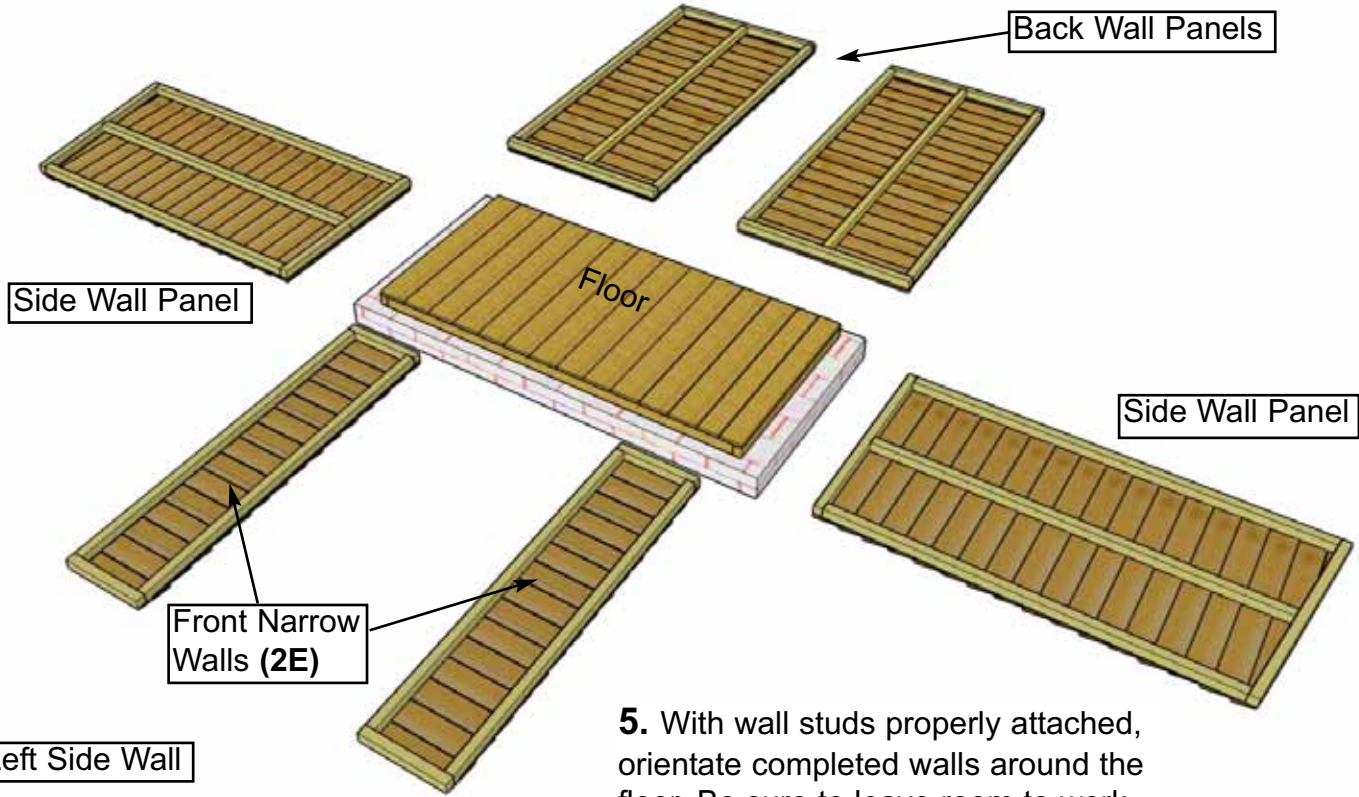

5. With wall studs properly attached, orientate completed walls around the floor. Be sure to leave room to work. **Front Narrow Wall (2E)** will be required in this section.

Before completely attaching walls to floor (**Steps 6-12**), check to make sure door opening is 41" wide. See **Step 13** for illustration.

Angled Left Side Wall

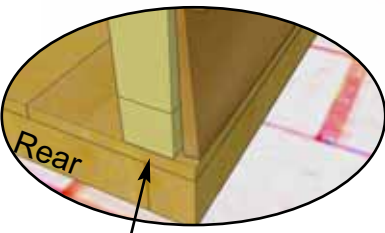
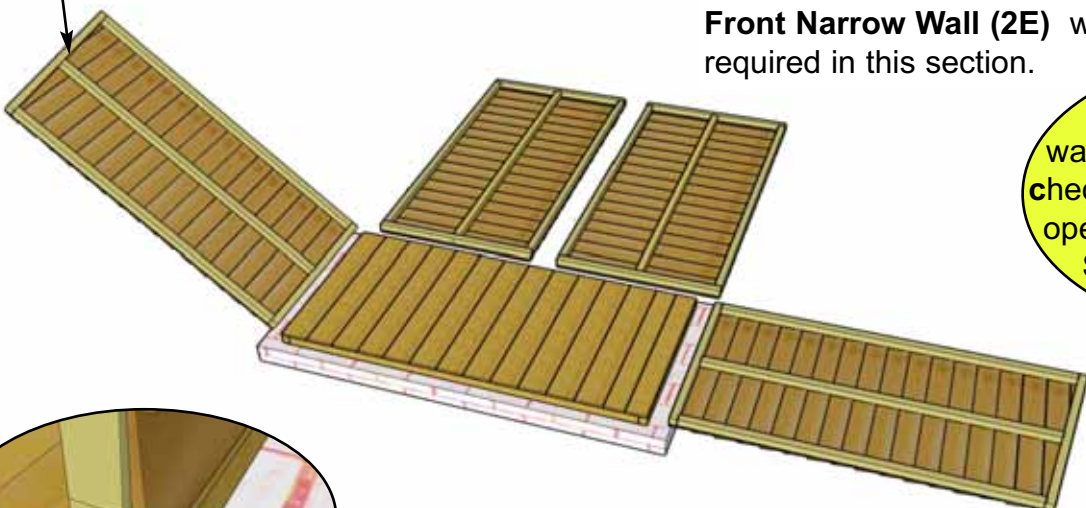

4 - 2 1/2" Screws

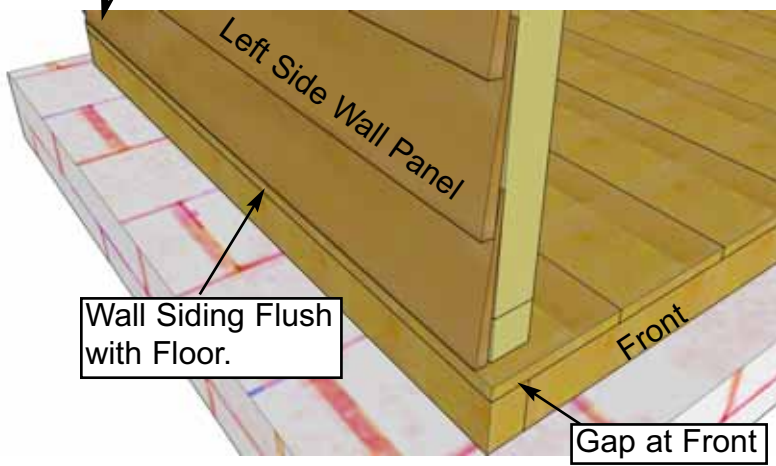
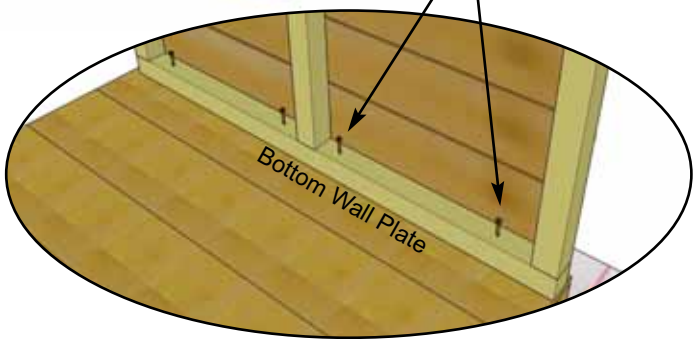

6. Starting with angled left side wall, lift up and position so framing is flush with floor at rear of shed. Make sure wall siding is flush with outside of floor on the side. In the front, there will be a gap of approximately 5/8". When wall is positioned correctly, secure bottom wall plate to floor with **4 - 2 1/2" Screws (C)**.

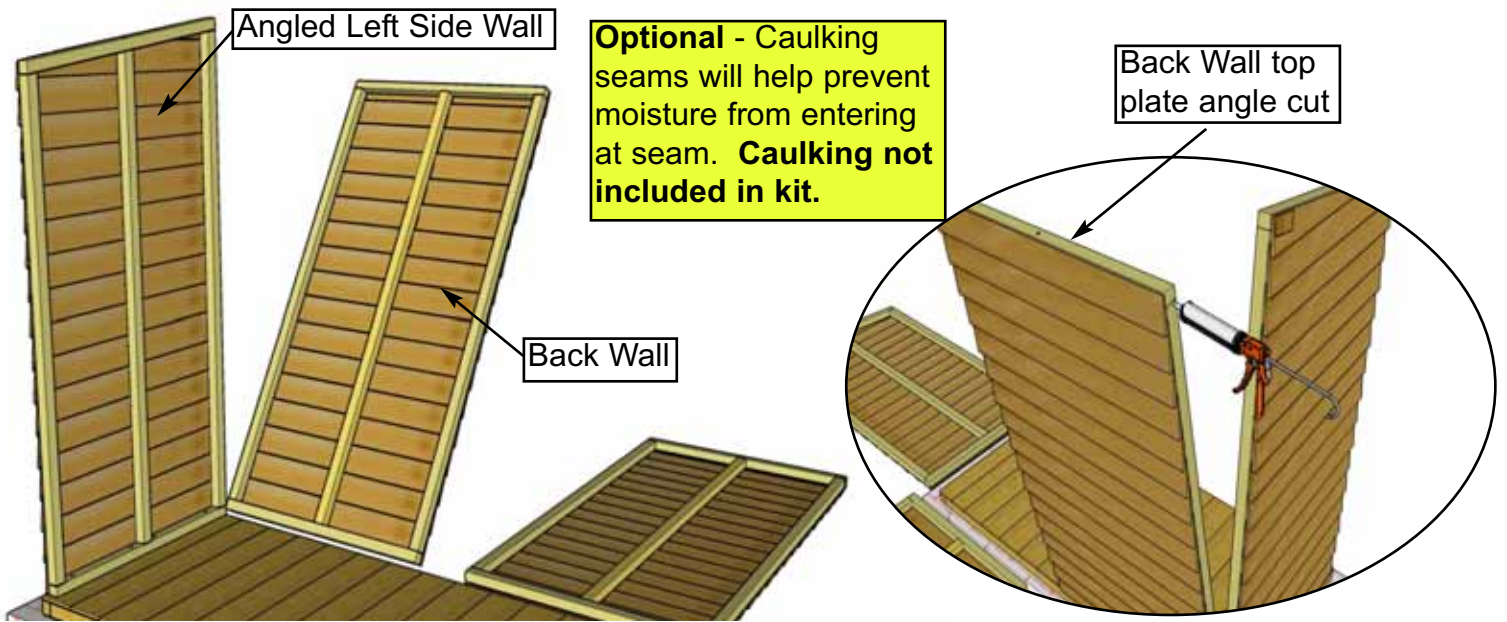

7. With your helper holding the side wall panel, position a **Back Wall Panel (2C)** in rear corner. **Important: Align Wall Siding Flush with Floor Framing.**

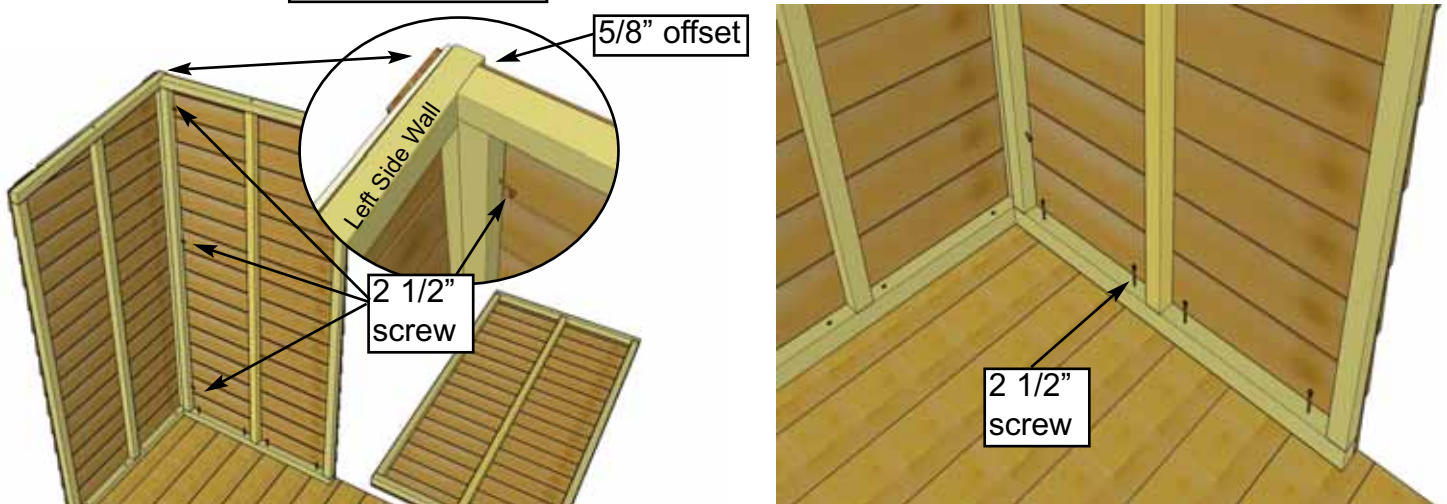
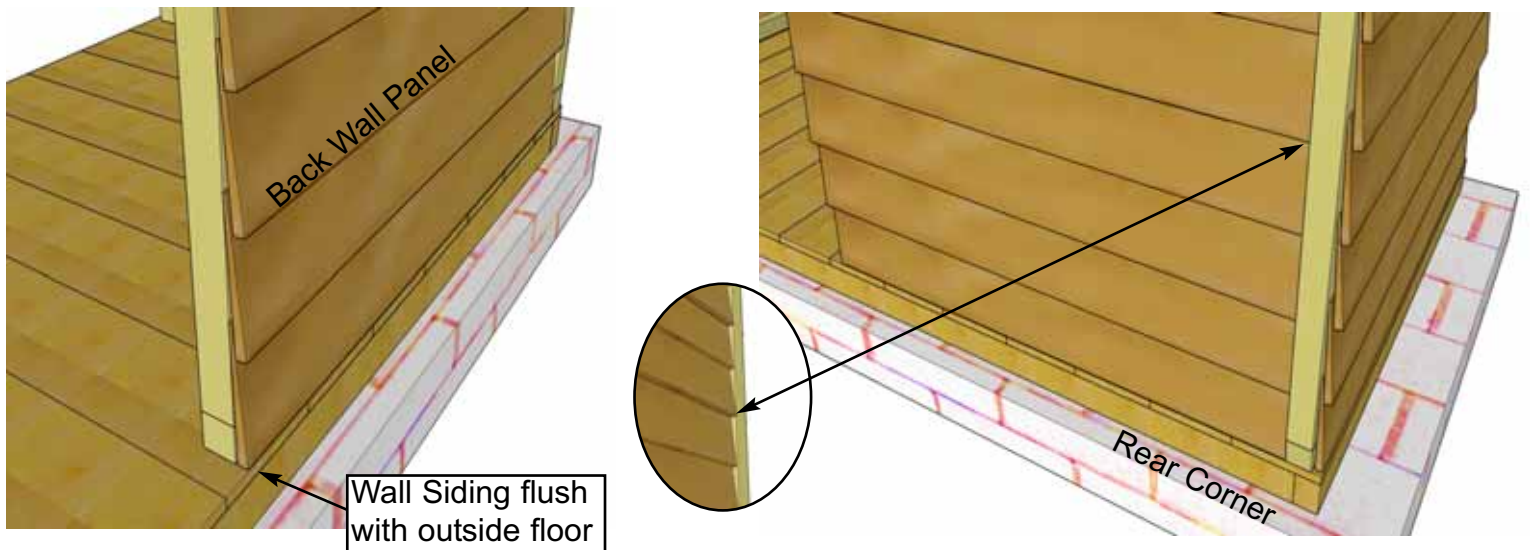

8. When side and back walls are aligned in corner correctly, wall framings will be offset. Screw wall framings together with **3 - 2 1/2" Screws (C)**. Secure bottom wall plate to floor with **4 - 2 1/2" screws (C)**.

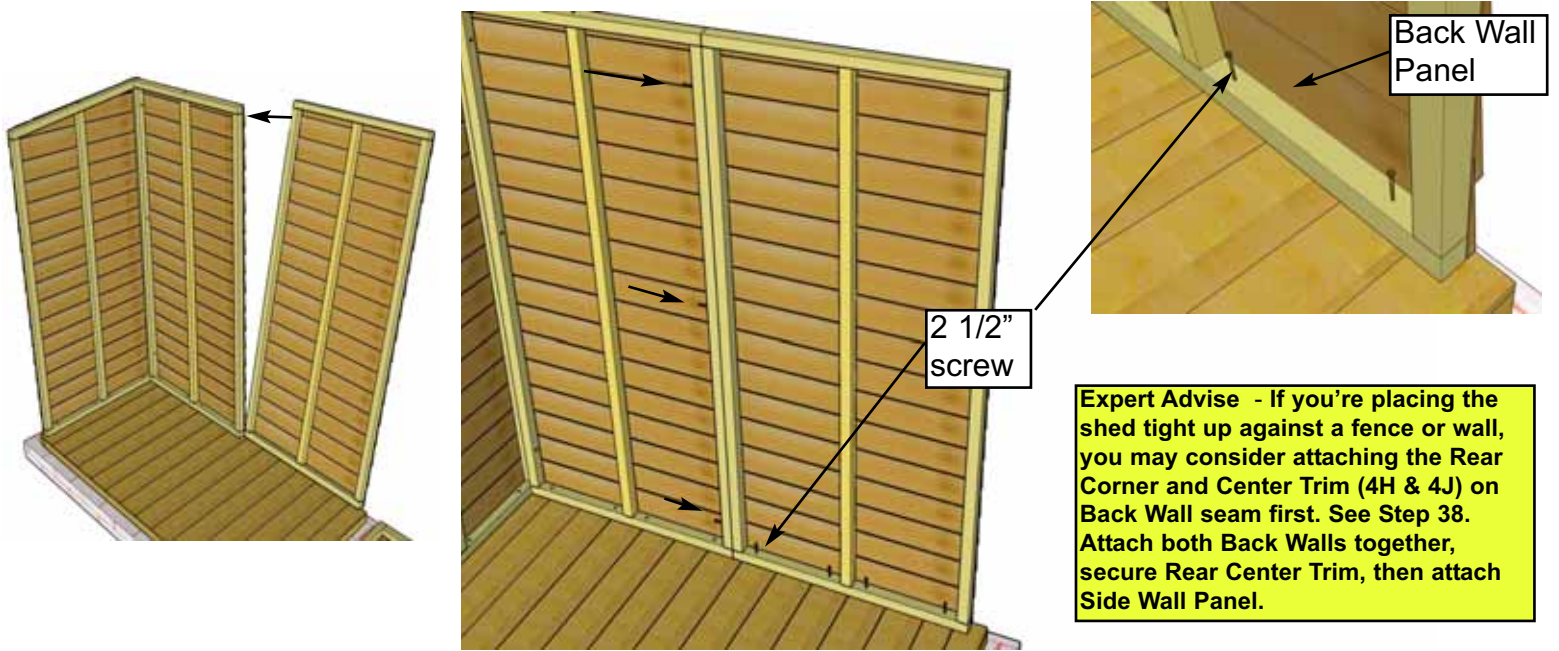

9. Position 2nd **Back Wall Panel (2C)** on Floor as per **Step 8**. Attach wall frames together at top, middle and bottom with 3 - 2 1/2" screws. Secure bottom wall plate to floor with 4 - 2 1/2" **Screws (C)**.

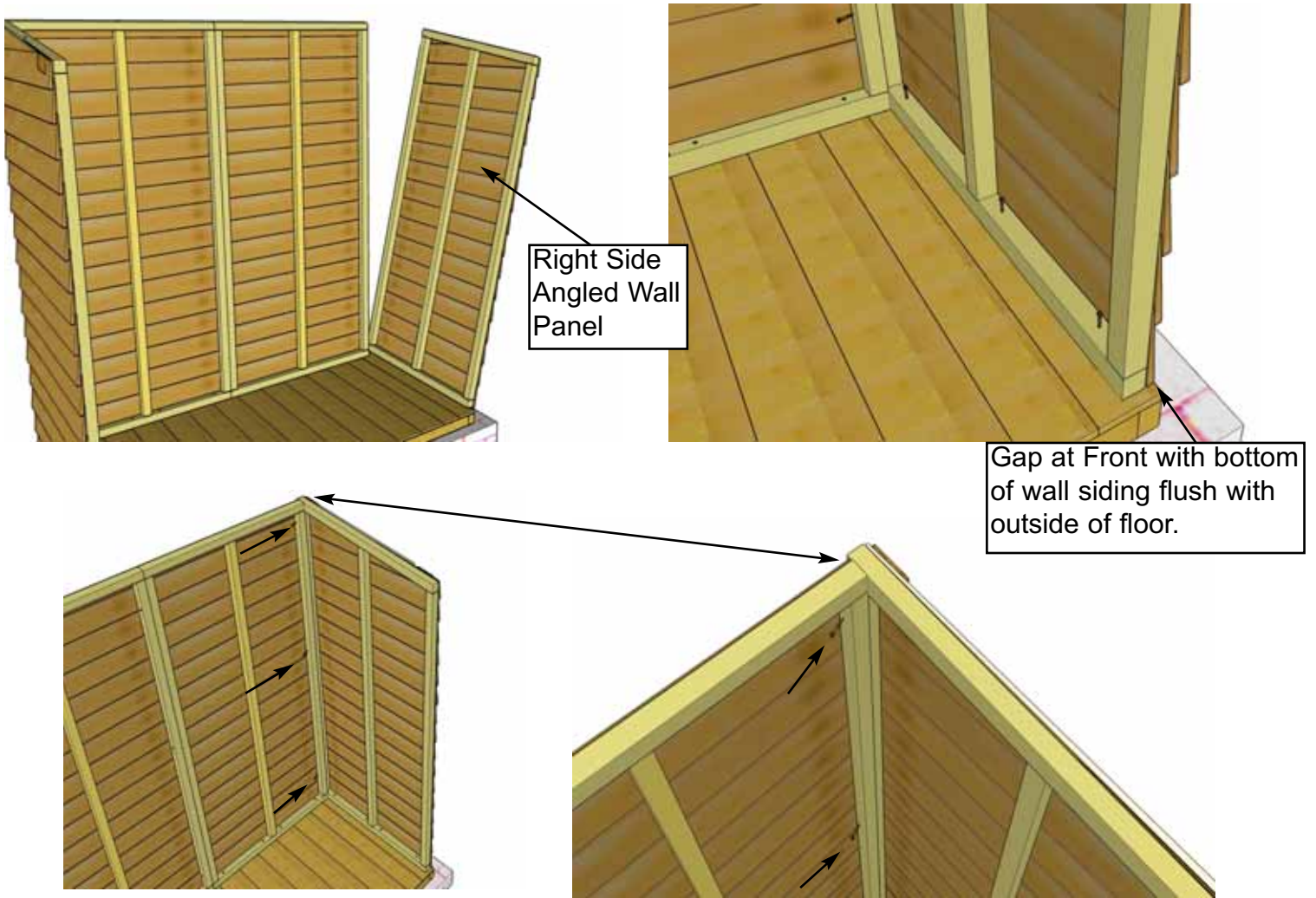

10. In the corner, align and attach right **Side Wall (2A)** framing to back wall framing as per **Steps 7 & 8**. Secure bottom wall plate of side wall to floor with 4 - 2 1/2" **Screws (C)**.

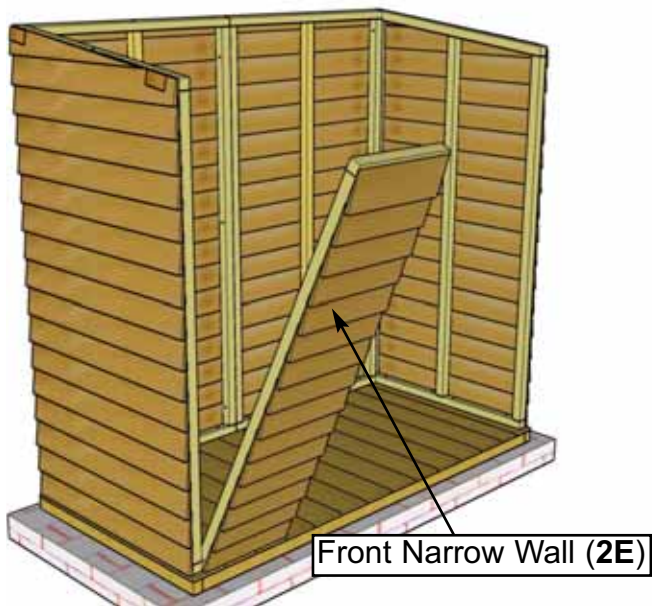

11. Locate **Front Narrow Walls (2E)** and position wall framing flush with side wall framing in corner. Make sure narrow wall is positioned right side up.

Wall Siding Flush with Floor Framing.
Before attaching, make sure door opening is 41" wide.
See Step 13.

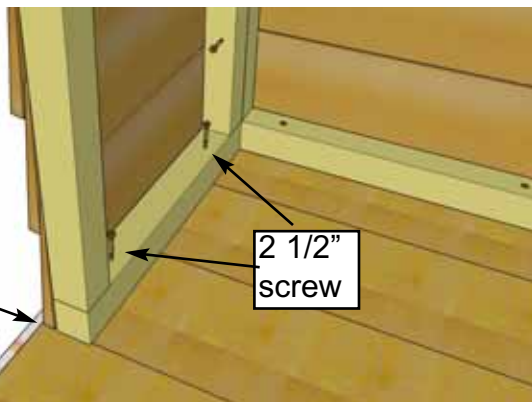

12. Align butt or bottom of wall siding flush with outside of floor framing. When correctly positioned, secure bottom wall plate to floor with 2 - 2 1/2" Screws (C). Attach vertical wall framings together at top, middle and bottom with 3 - 2 1/2" Screws (C).

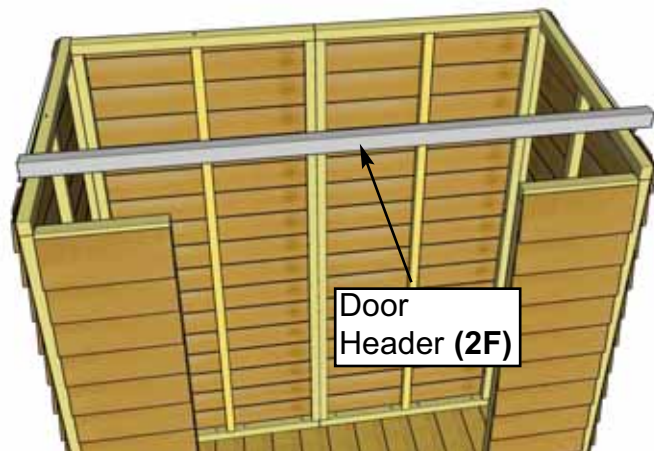
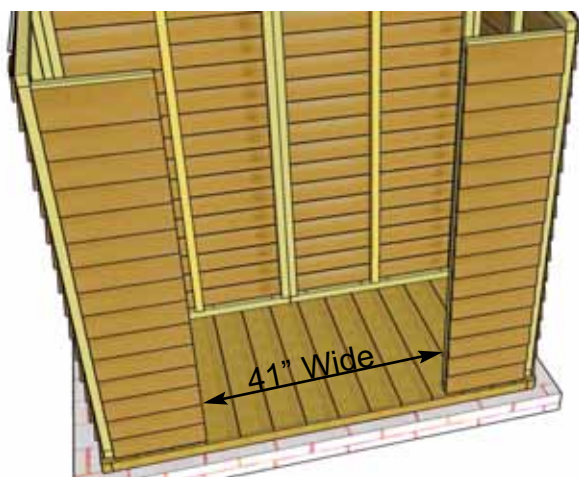

13. Align and attach the second front narrow wall panel as per **Step 12**.

14. Locate **Door Header (2F)** (1 1/2" x 1 1/2" x 70") and place on top of front narrow wall framings.

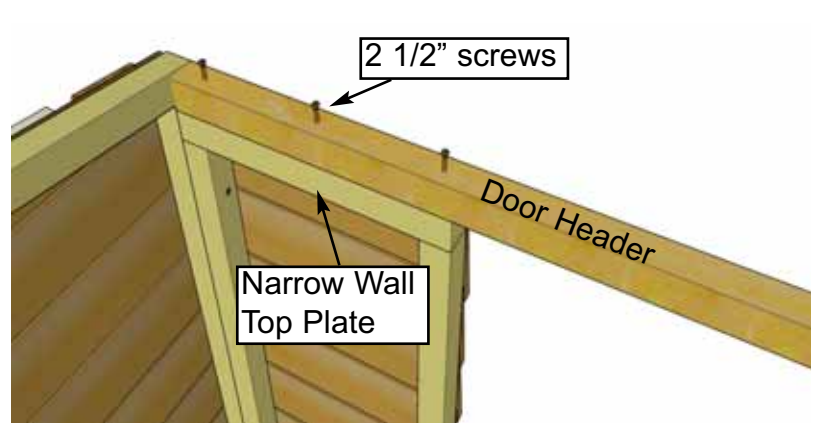
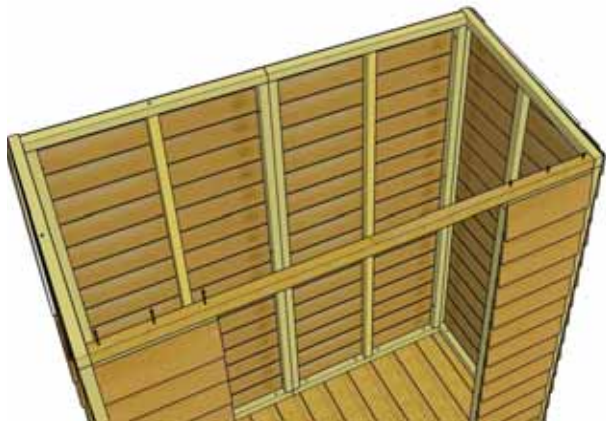

15. With door header positioned evenly on narrow wall top plates and flush against side wall top framing, secure using **6 - 2 1/2" Screws (C)** screwing down from the top of door header down into the upper narrow wall plates. Have your helper push side walls against end of door header to achieve tight fit if possible.

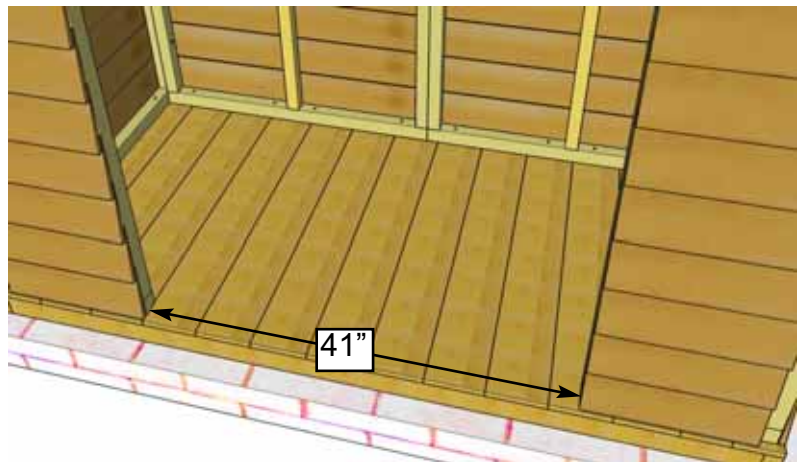
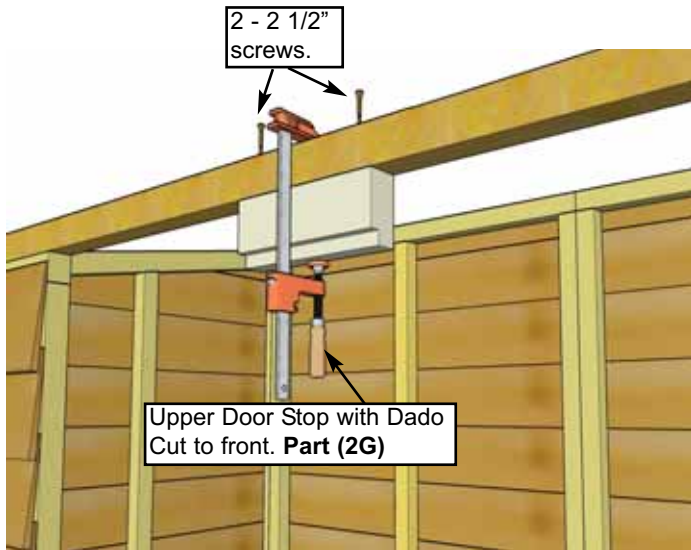

16. Attach **Upper Door Stop (2G)**. Dado cut aligned to the front. Center on door header and attach with **2 - 2 1/2" Screws (C)**. Screw down from the header into Stop. Use Clamp to hold stop.

17. When all walls are attached together, check door width at top and bottom. Door width should be 41" wide. If required, loosen narrow and side wall plate screws, adjust door width and re-secure. There can be an 1/8" tolerance in the width but top and bottom width should be the same.

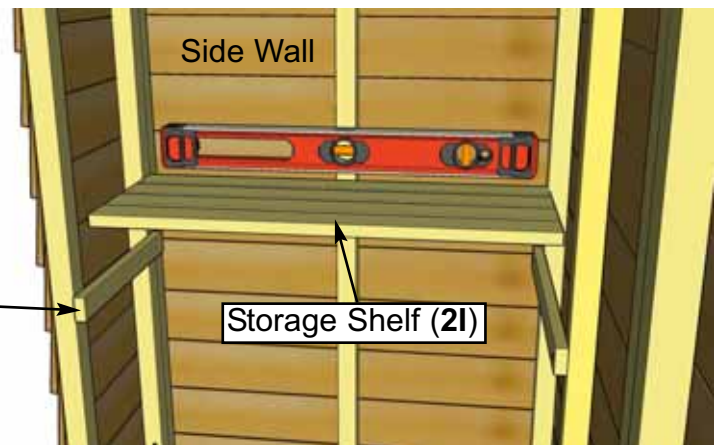
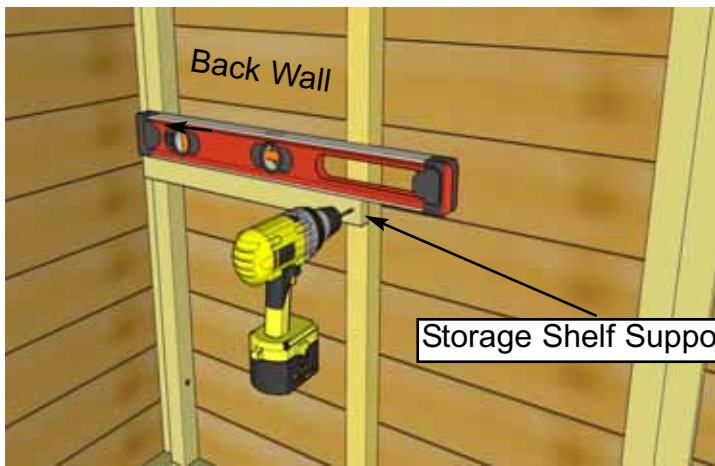

18. Storage Shelf positioning is flexible so decide what height configuration suits your needs. Gather your **Storage Shelf Supports (2H)**. The short Support (14 1/2") attaches to the narrow wall, the long (18 1/4") to the back wall. Position using a Level, and drill Pilot Holes to prevent ends of Supports from splitting. Attach first Support using **2 - 1 1/4" Screws (E)**. Place Storage Shelf on attached Support, Level, and mark position of 2nd Support. Pilot Hole and secure 2nd Support.

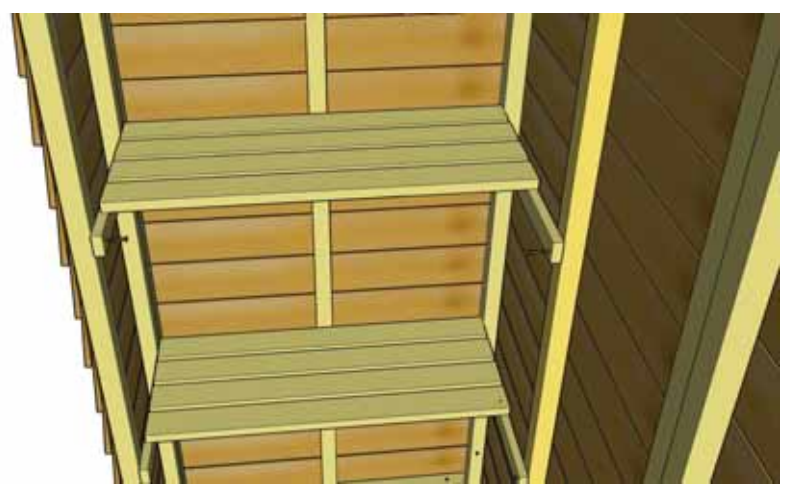

19. Place **Storage Shelf (2I)** on top of supports and secure with **4 - 1 1/2" Finishing Nails (K)**. Complete 2nd Shelf (if desired) as per **Steps 18 & 19**.

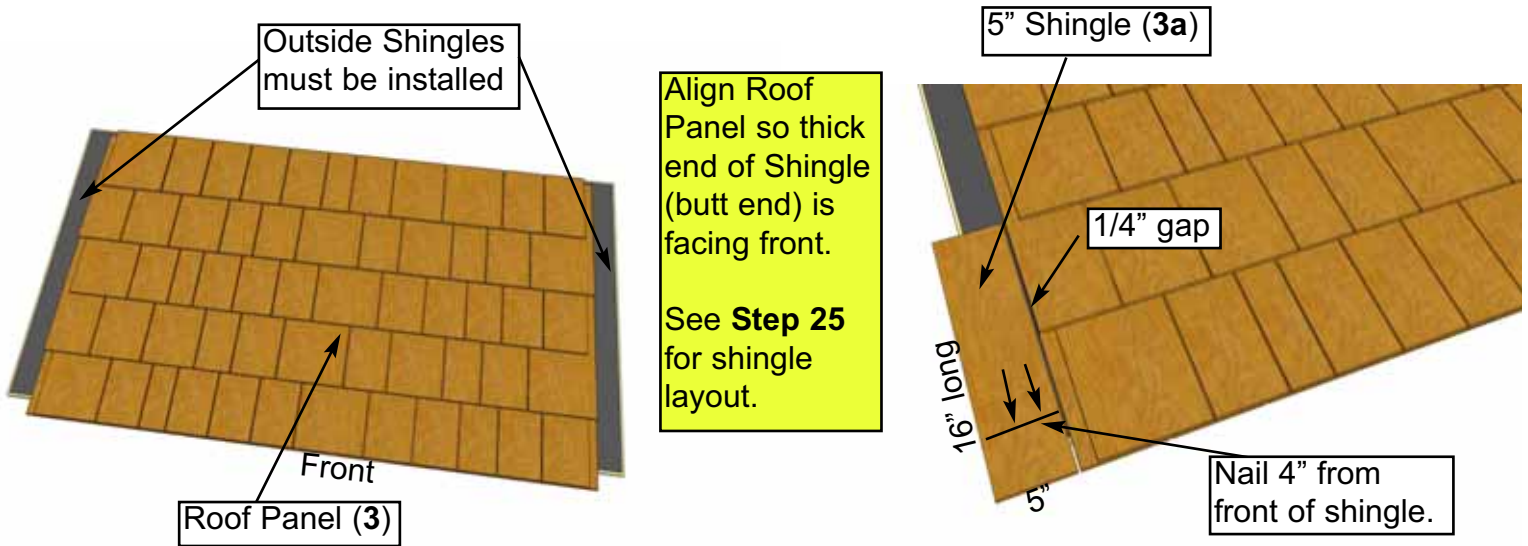

20. Lay **Roof Panel (3)** on flat level ground. Note, overhanging Outside Shingles have been removed to avoid shipping damage and need to be installed. Locate **(3A , 3B & 3C) Shingles**. There are 6 - 5" wide x 16" long **(3A)** Shingles, 4 - 6" wide x 16" long **(3B)** Shingles and 2 - 6" wide x 12" long **(3C)** Shingles. Position and attach **(3A)** Shingle (5" wide) on roof panel with **2 - 7/8" Shingle Nails (M)**. See above for details.

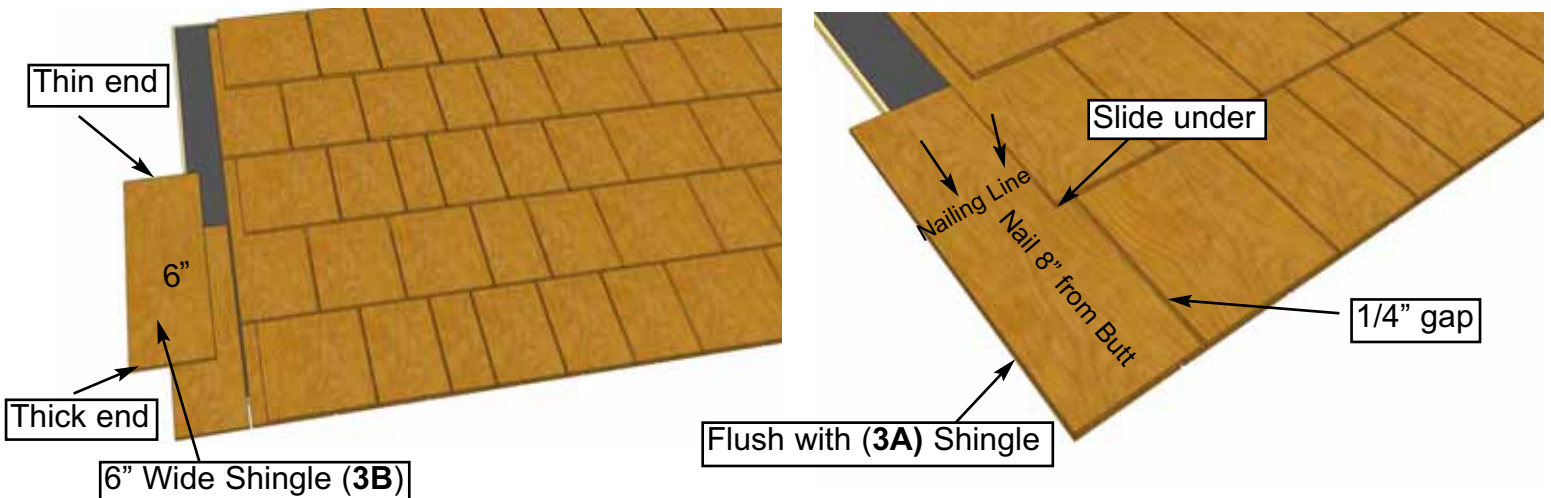

21. Place and attach **(3B)** Shingle (6" wide) directly on top of Shingle **(3A)**. Shingle **(3B)** will slide under 2nd row shingle. Secure with **2 - 7/8" Shingle Nails (M)** 8" from butt.

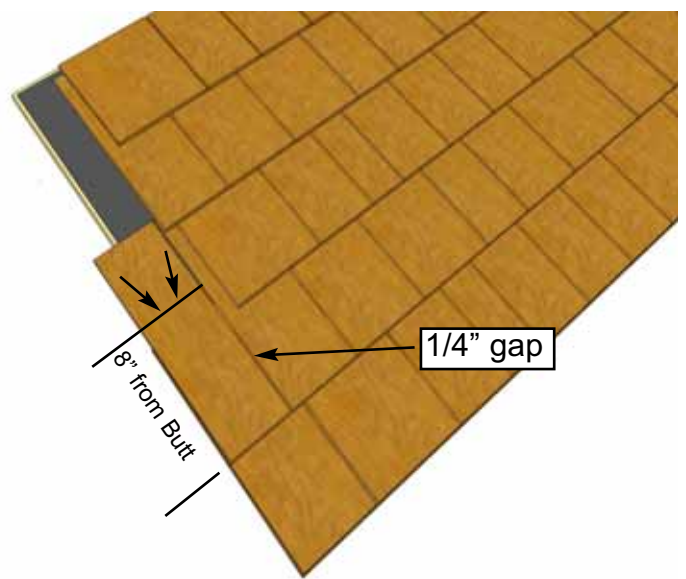
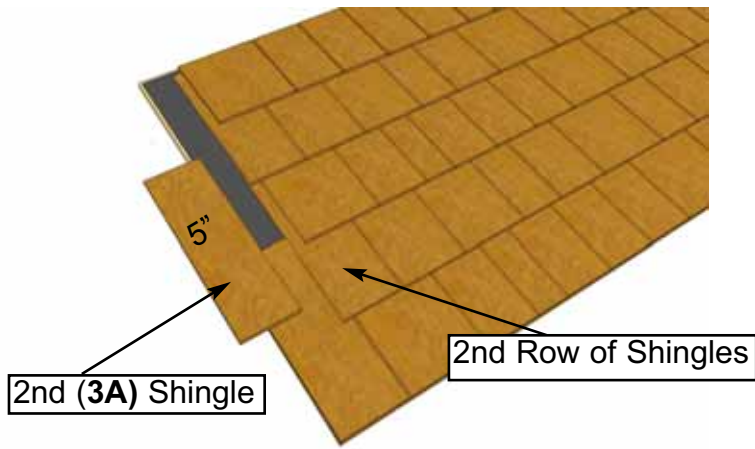

22. Place and attach second (3B) Shingle (5" wide) in line with 2nd row of shingles. Shingle (3A) will partially cover shingle (3B). Secure with 2 - 7/8" Shingle Nails (M) 8" from butt.

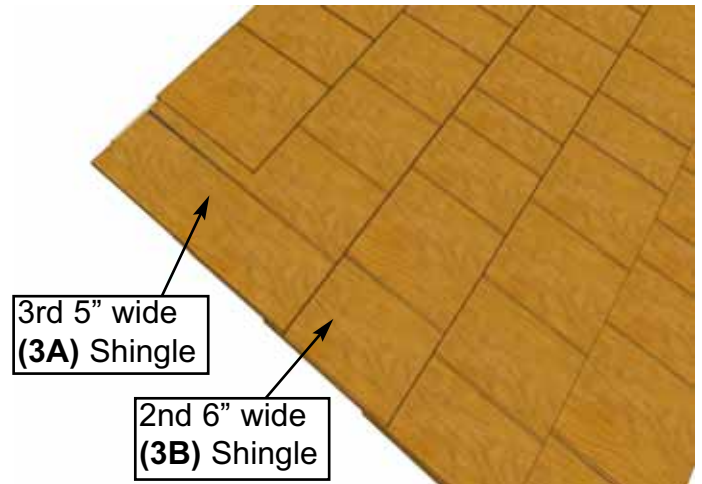
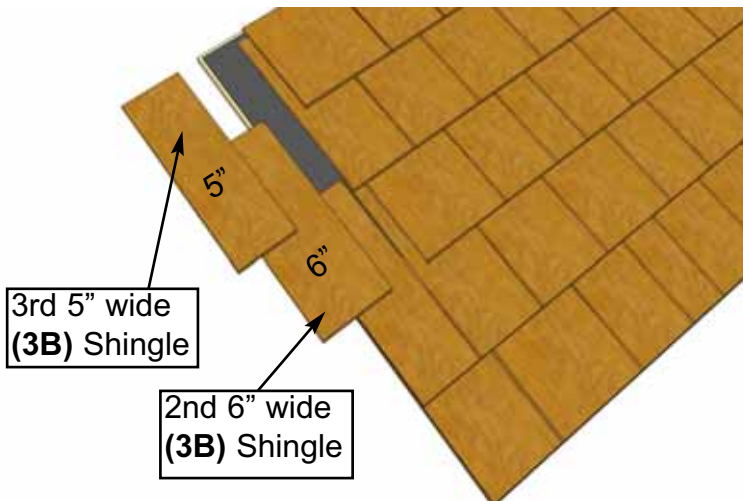

23. Place and attach 2nd (3B) Shingle (6" wide) in line with 3rd row of shingles. Shingle (3B) will partially cover shingle (3A). Secure with 2 - 7/8" Shingle Nails (M) 8" from Butt. Complete attachment of 3rd 5" wide (3A) shingle.

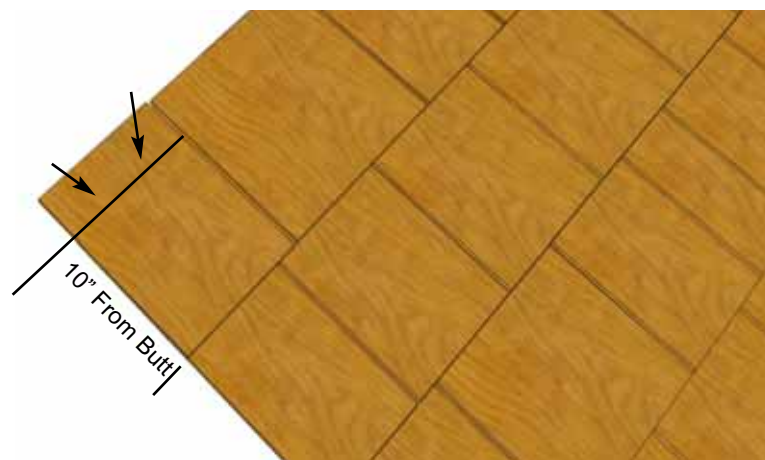
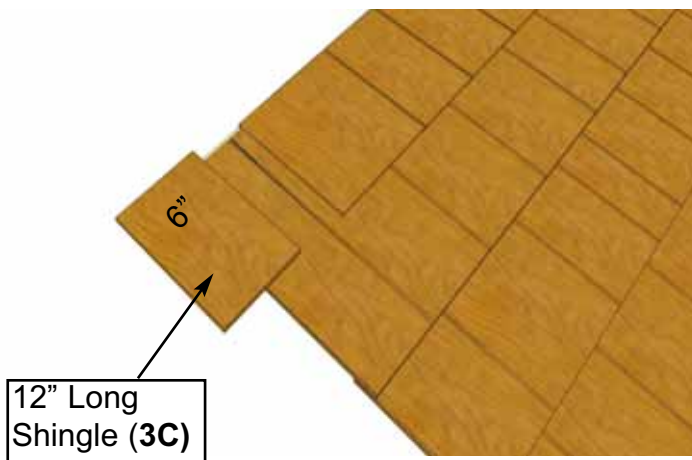

24. To finish end, place and attach (3C) shingle (6" wide x 12" long) in line with 5th and final row of shingles. Shingle (3C) will partially cover shingle (3B). Secure with 2 - 7/8" Shingle Nails (M) 10" from butt.

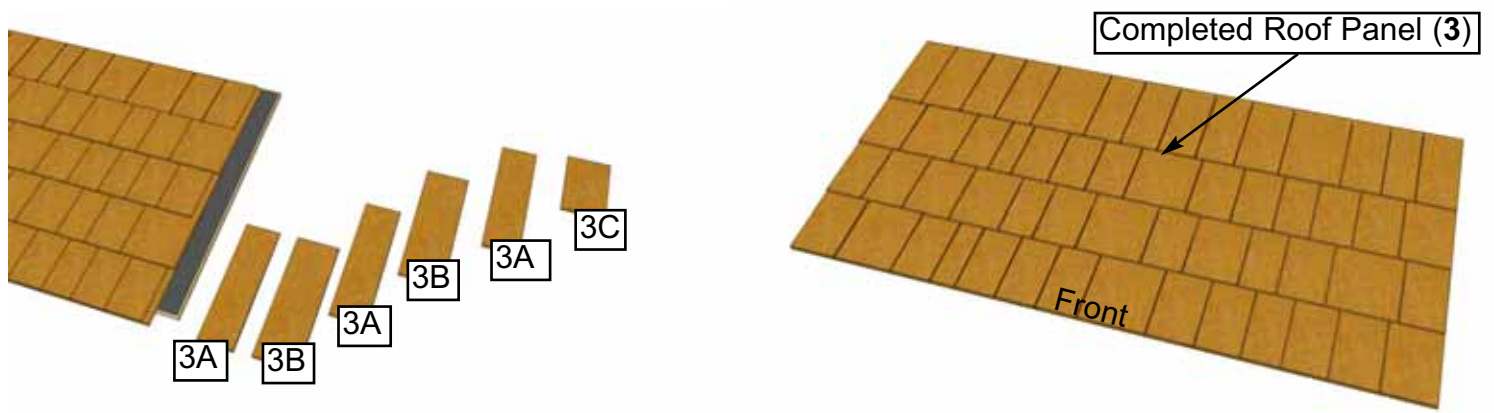

25. Complete attachment of shingles on opposite side of roof panel following **Steps 20-24.**

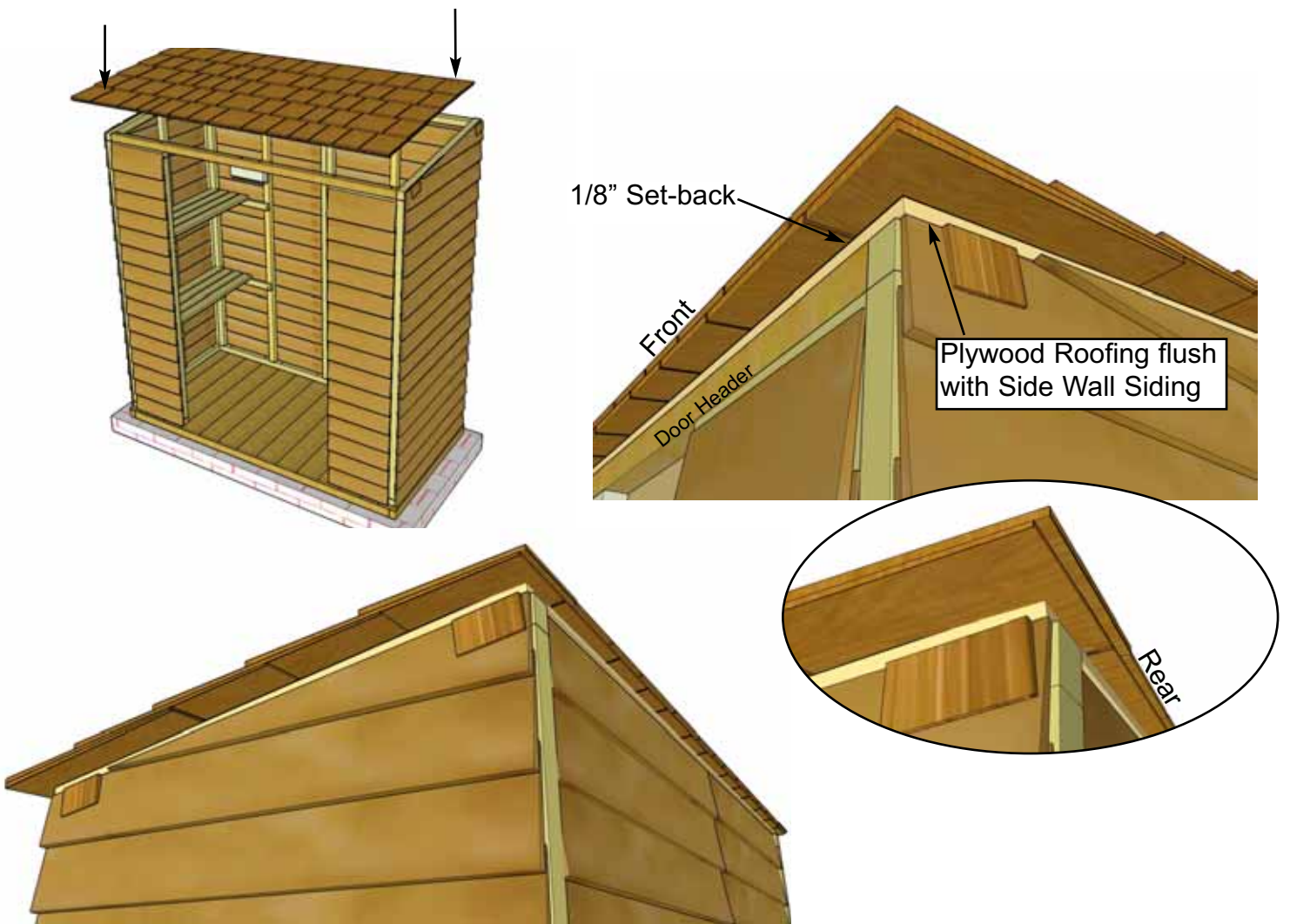

26. Lift up completed cedar shingle roof panel and place on upper wall framing. In the front, align plywood roofing 1/8" back from door header. On the side, plywood should be flush with side wall siding. Equally space roof from side-to-side. In the rear, plywood should sit on back wall top plate.

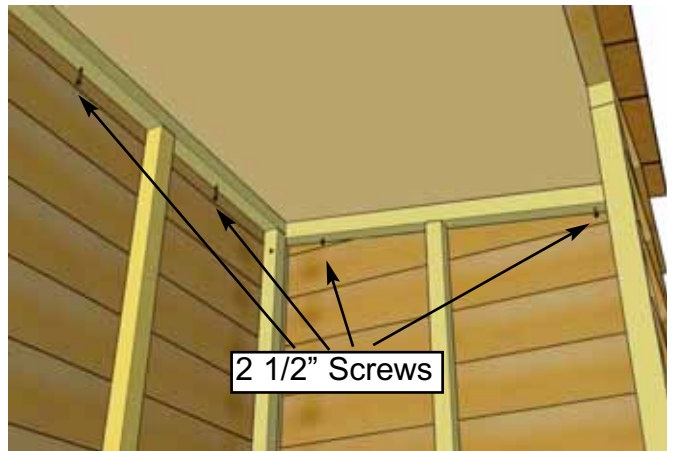
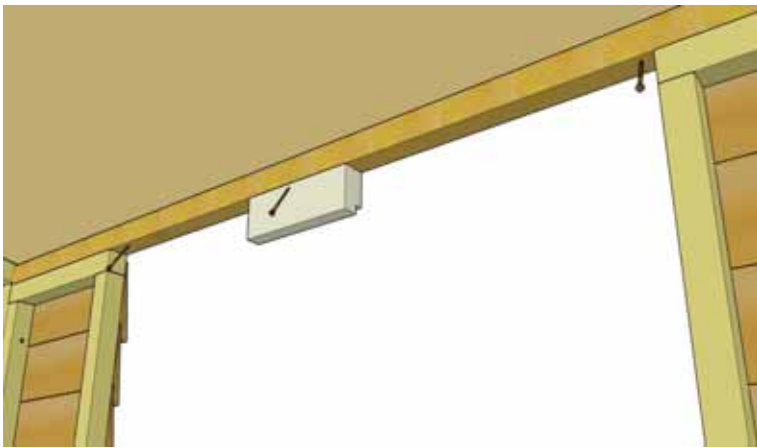

27. From inside the shed, start securing the roof by screwing the door header into Roof Panel on an angle with **3 - 2 1/2" Screws (C)**. Make sure screw tips do not go completely through roof panel. On the sides and rear, screw from upper framing into Roof Panel. Use 2 screws per each wall panel. Screw on an angle and make sure screw tips do not go completely through roof panel.



28. Locate 2 **Front Filler Trims (4A)** (**1 1/2" x 5/8" x 65"**). Filler trim will be covered by corner trim in **Step 37**. Attach in each front corner with **6 - 1 1/2" Finishing Nails (K)**.

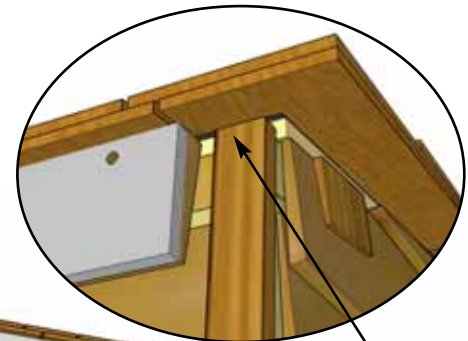
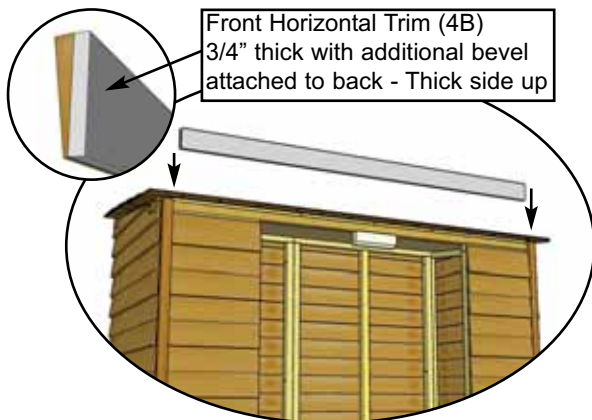

29. Locate **Front Horizontal Trim (4B)** (**3 1/2" x 1 1/4" thick at top x 68 1/4"**). Position horizontal trim tight up underneath roof panel. From side-to-side evenly space. Secure with **6 - 2 1/2" Screws (C)** into door header.



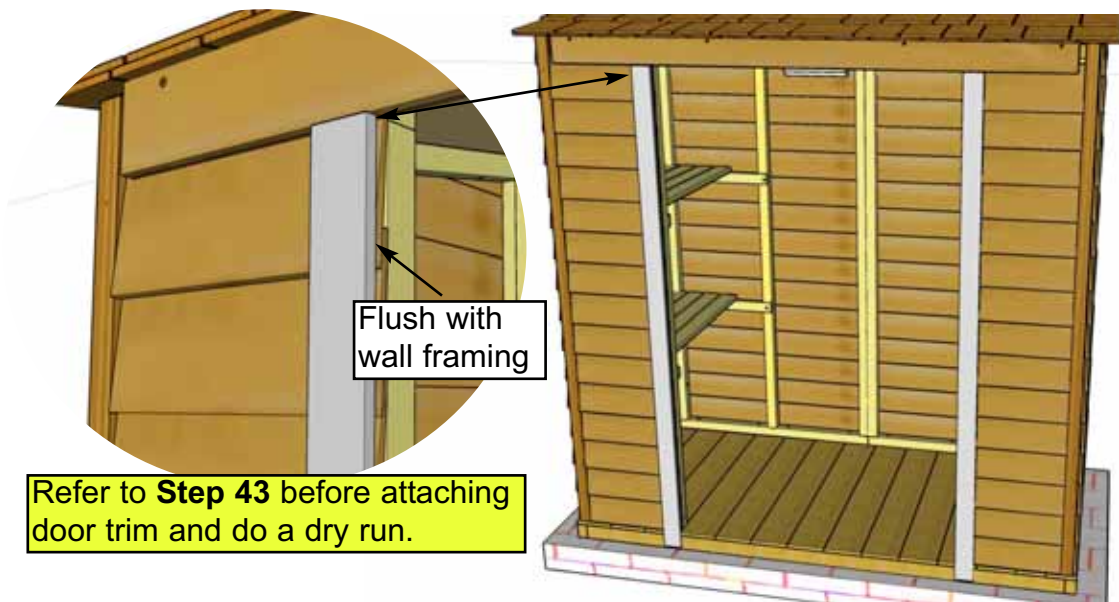

Only one nail until spacer attached on Step 31.



1 nail into butt of 2nd piece of wall siding.

30. Locate 2 **Vertical Door Frame Trims (4C)** (1/2" x 2 1/2" x 64 1/4"). Position on front narrow wall flush with outside of wall framing and tight underneath front horizontal trim. Attach with 1 - 1 1/2" **Finishing Nail (K)** on second piece of wall siding into the butt (where trim and siding touch).

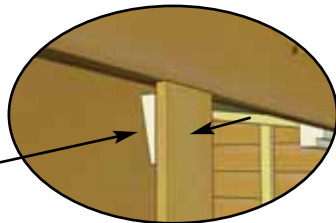

31. Locate 2 **Door Trim Spacers (4D)** found in the Hardware Bag with **Plywood Spacer (UU)**. Slide door spacer between door trim and wall siding. Attach with 1 - 1 1/2" **Finishing Nail (K)**. Nail through trim and into spacer. **Complete attachment of door trim using 4 more 1 1/2" Finishing Nails (K).** Make sure to align trim accordingly. Complete both sides.

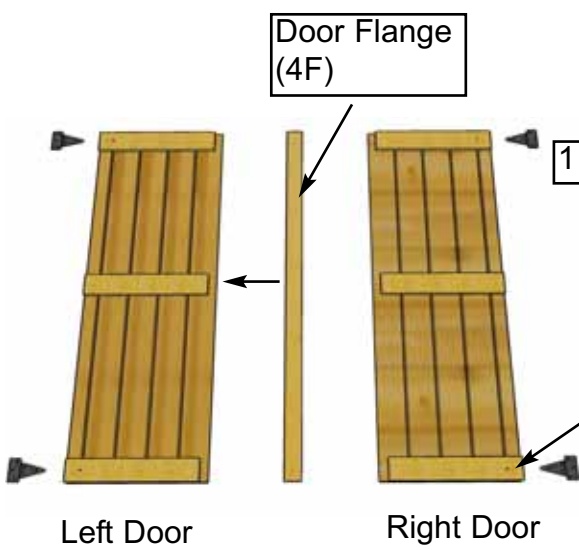

Drill Pilot Holes to prevent splitting.

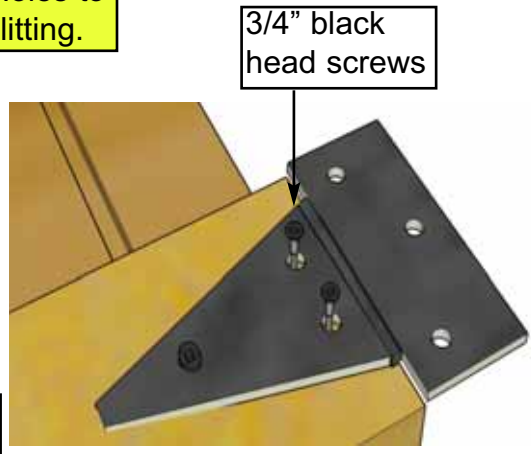
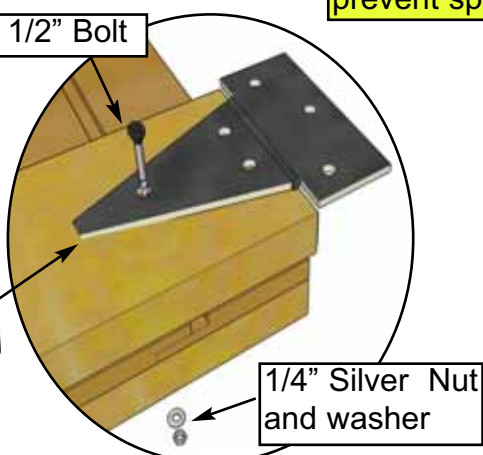

32. Locate **Doors (4E- 2 identical)** and **Door Flange (4F)** (1/2" x 2 1/2" 61 3/8"). Orientate Doors so the outside of each door is facing up and the pre-drilled holes located in each corner are positioned to the outside. Locate **Black T- Hinges (U)**. Attach each hinge to door as above with 1 - 1 1/2" **Black Headed Bolt (FF)**, and a 1/4" **Silver Nut**, using a 3/8" wrench. Finish hinge by securing with 2 - 3/4" **Black Headed Screws (J)**. Drill small pilot holes first to prevent wood from splitting. Complete both doors(4 Hinges).

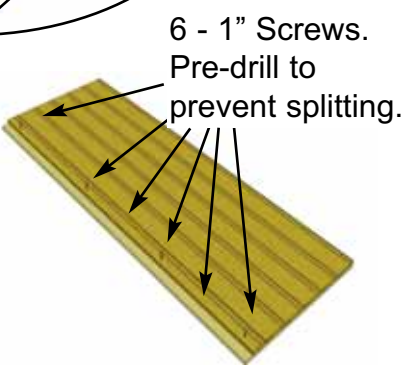
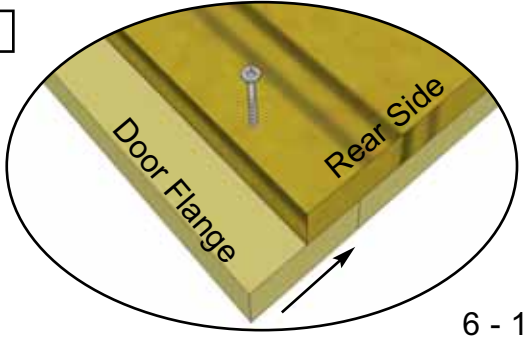
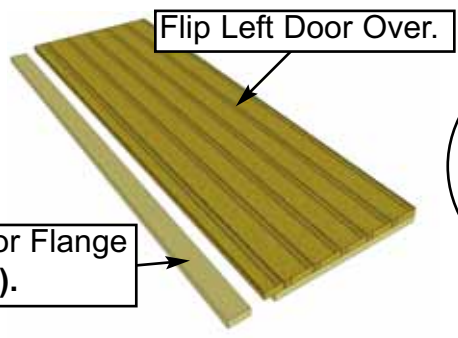
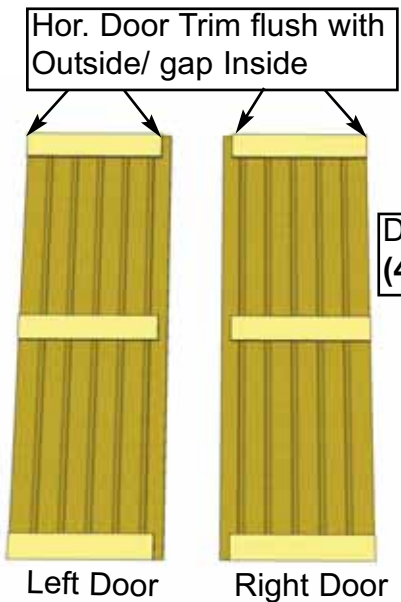

33. Flip left door over to attach **Door Flange (4F)**. Push flange tight against horizontal door trim. Attach with **6 - 1" Silver Screws (F)**. Position flange tight against horizontal door trim and even with trim on top and bottom. If out slightly, make sure top horizontal trim and flange are even. Pre-drill with 1/8" bit to prevent wood from splitting.

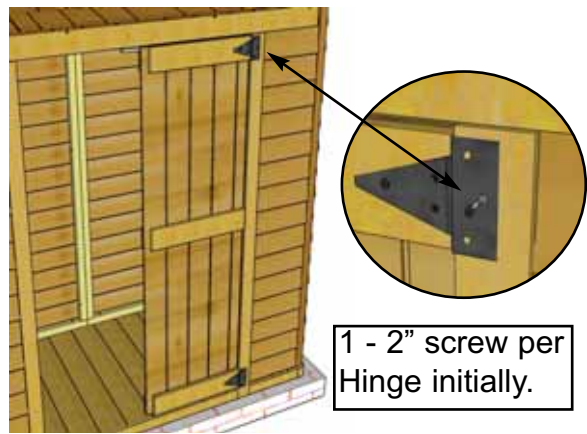
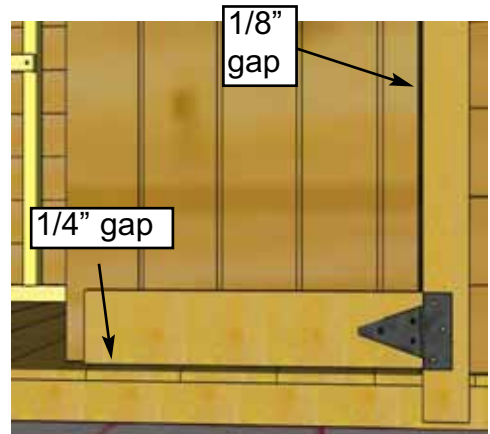

34. Starting with right door first, lift and position door in opening. Leave a 1/8" gap on right side and 1/4" gap on the bottom. Use a **Shim Shingle (4R)** to shim the door at bottom to help position door evenly. When door is aligned correctly, screw hinge into vertical door frame trim with **1 - 2" Black Headed Screws (H)**. Use only 1 screw initially per hinge until both door alignments are confirmed. Drill pilot holes to prevent wood from splitting.

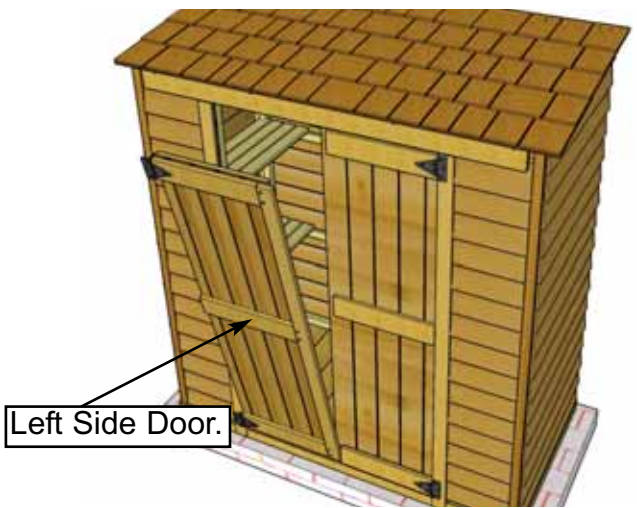

35. Position left side door (with flange) as per **Step 34**. Once again, use only **1 - 2" Black Headed Screw (H)** per hinge initially to secure door to vertical door frame trim.

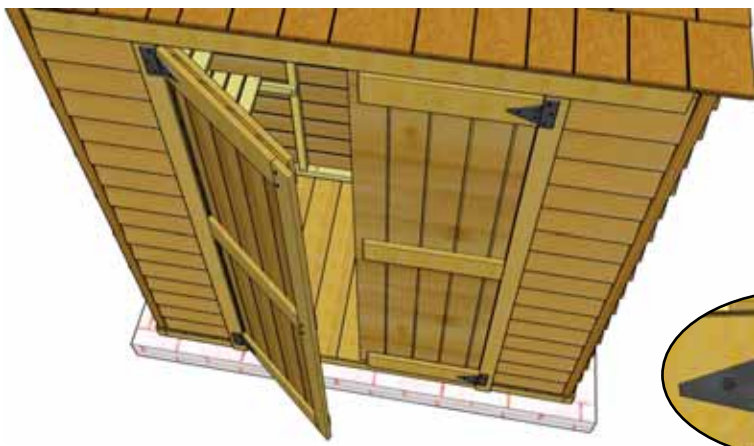

36. With both Doors partially attached, check to see doors open and close correctly. Make any necessary adjustments and when satisfied, completely secure hinges to vertical door frame trim with **two more 2" Black Headed Screws (H)** per hinge. Drill pilot holes to prevent wood from splitting.

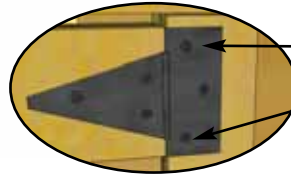

2 more - 2" screw per Hinge

Note: Trim pieces are graded with the best face being rough. Rough sawn cedar is much easier to paint and stain and is the industry standard.

Expert Advice: Do a dry run with front and rear corner trims before attaching. Confirm the rough face is configured correctly and small trim gaps are satisfactory before attaching.



Front Side Corner Trim (4H) 2 1/2" wide. Angle cut 8 deg. at top

Front Corner Trim (4G) 3 1/2" wide.

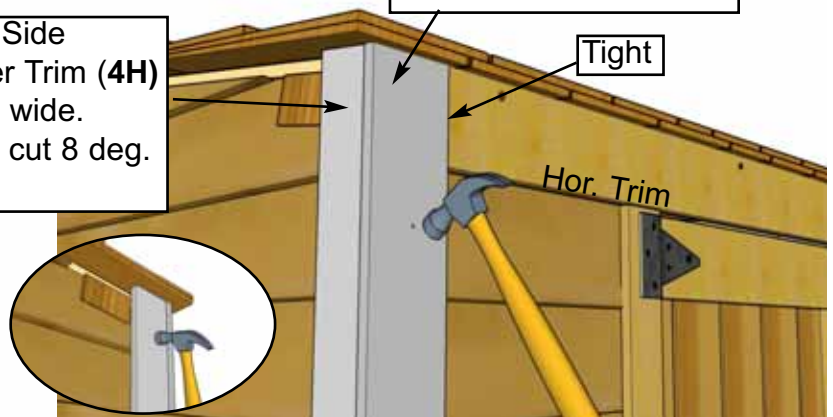

37. Locate a **Front Corner Trim (4G)** (1/2" x 3 1/2" x 67 3/4") (1 for each front side), and **Front Side Corner Trim (4H)** angle cut 8 deg. at top (1/2" x 2 1/2" x 68 1/4"). Angled side trim pieces are unique to each corner and are attached **rough side out**. Starting in one corner, position both trims up tight underneath roof shingles. Align front corner trim tight against horizontal door trim. Front corner trim will cap front side corner trim. When correctly aligned, attach each piece with **6 - 1 1/2" Finishing Nails (K)**.

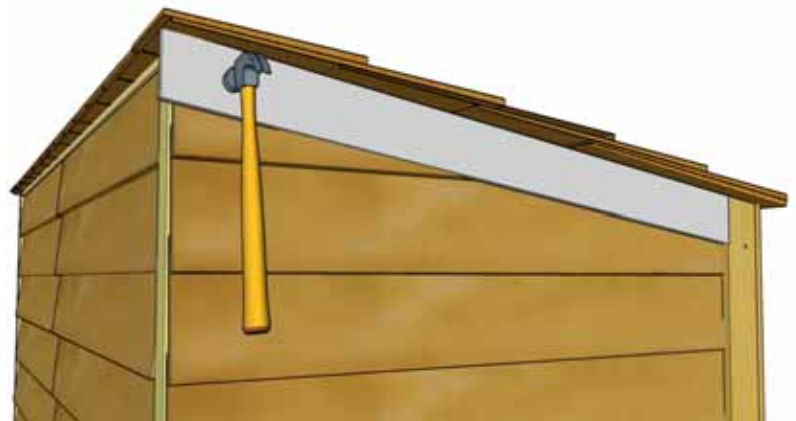
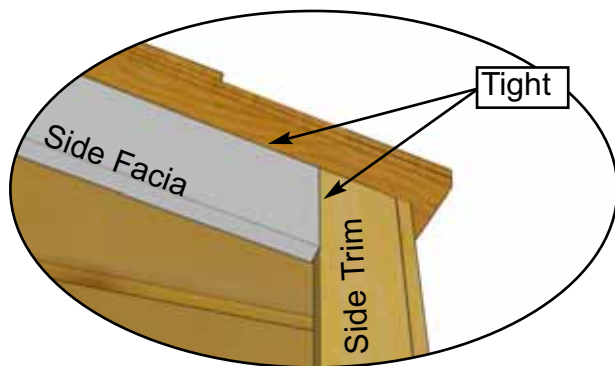

38. Continuing around the shed, place a **Side Facia Trim (4I)** angle cut both ends (1/2" x 2 1/2" x 33 7/8") tight against front side corner trim and snug underneath roof panel. Attach side facia into side wall cleats with **4 - 1 1/2" Finishing Nails (K)**.

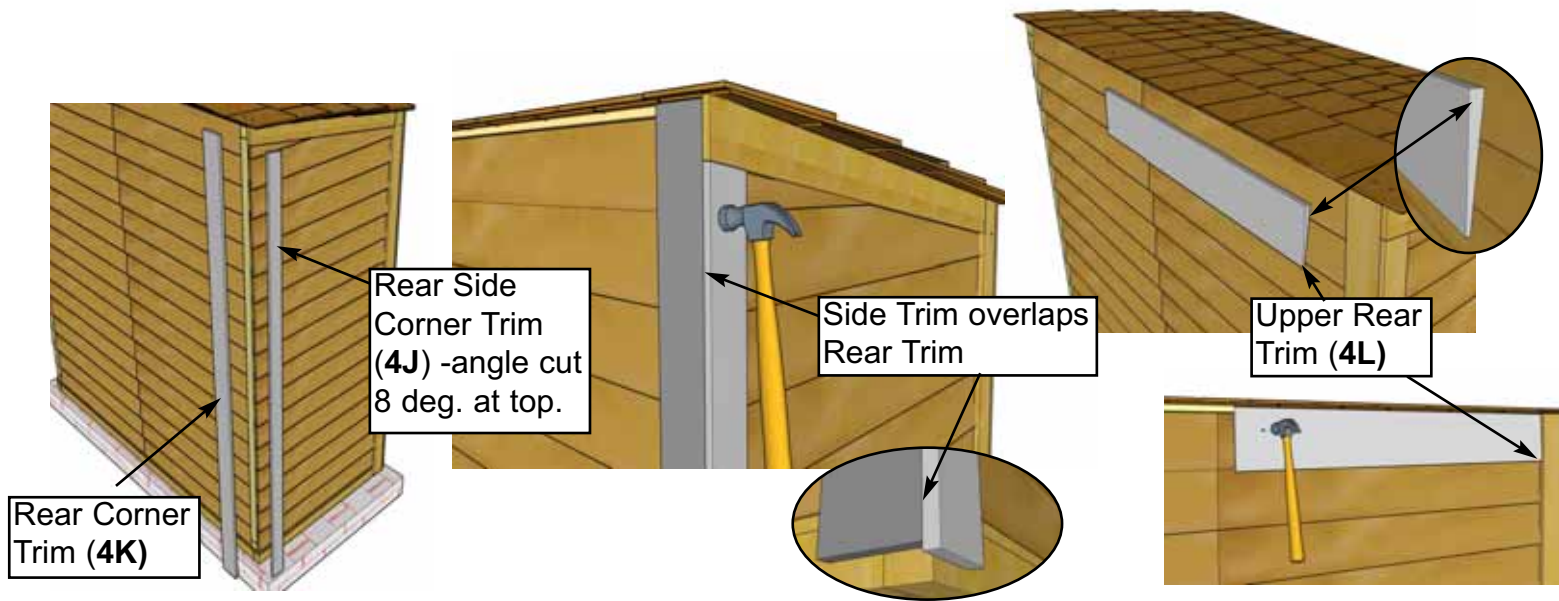

39. Locate a **Rear Side Corner Trim (4J)** angle cut 8 deg. at top ($1/2'' \times 2 1/2'' \times 70 1/4''$) and **Rear Corner Trim (4K)** ($1/2'' \times 3 1/2'' \times 71 3/4''$). Once again, angled side trim pieces are unique to each corner and are attached **rough side out**. Position side trim tight underneath side facia. Align rear corner trim tight underneath roof shingles. Side trim will cap rear trim. Attach each pieces with **6 - 1 1/2'' Finishing Nails (K)**. Locate **Upper Rear Trim - Bevel Siding (4L)** ($4 1/2'' \times 32 3/8''$). Align tight against rear corner trim and underneath roof. Attach with **4 - 1 1/2'' Finishing Nails (K)**.

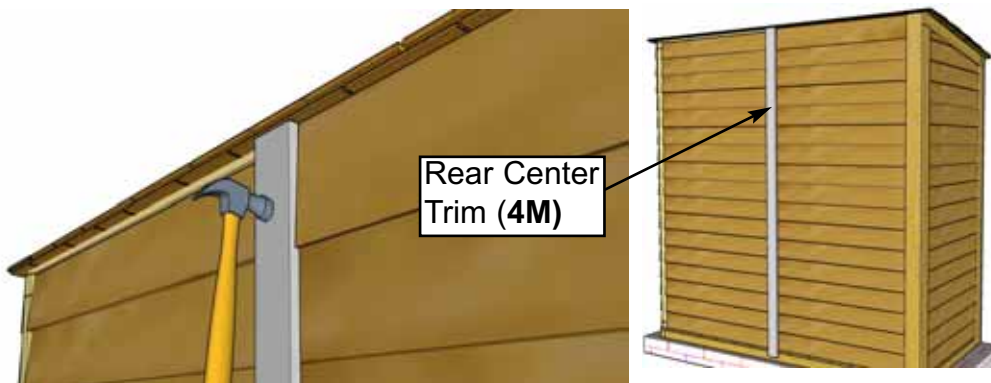

40. Locate **Rear Center Trim (4M)** ($1/2'' \times 2 1/2'' \times 71 3/4''$). Align tight against upper rear trim and underneath roof. Attach with **6 - 1 1/2'' Finishing Nails (K)**.



41. Complete other rear corner, side and front corner trims as per **Steps 37 - 39**.

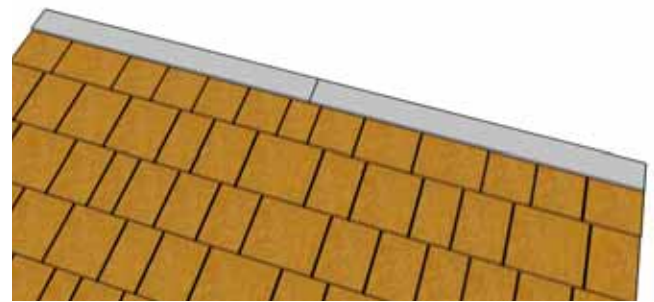
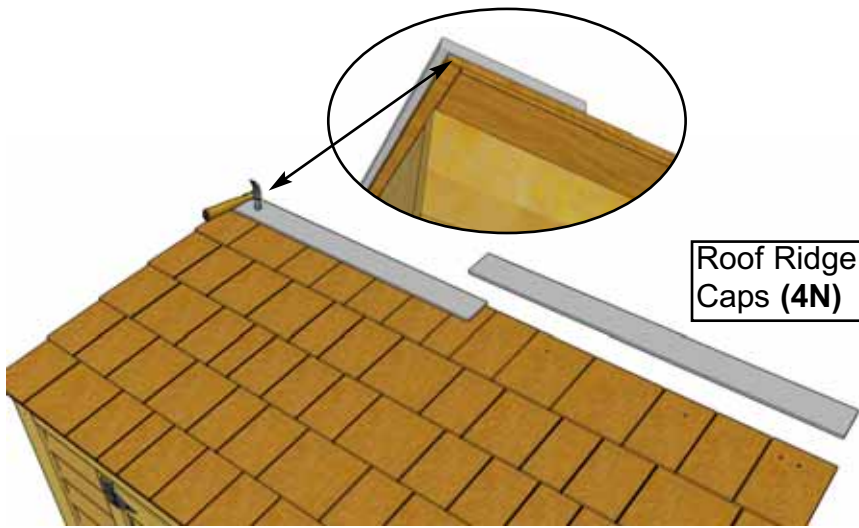

42 Using a Step Ladder, place both **Roof Ridge Caps (4N)** (1/2" x 3 1/2" x 39") on rear row of roof shingles. Ridge Caps will overhang shingles by 1/4". Attach each piece with 4 - 1 1/2" Finishing Nails (K).

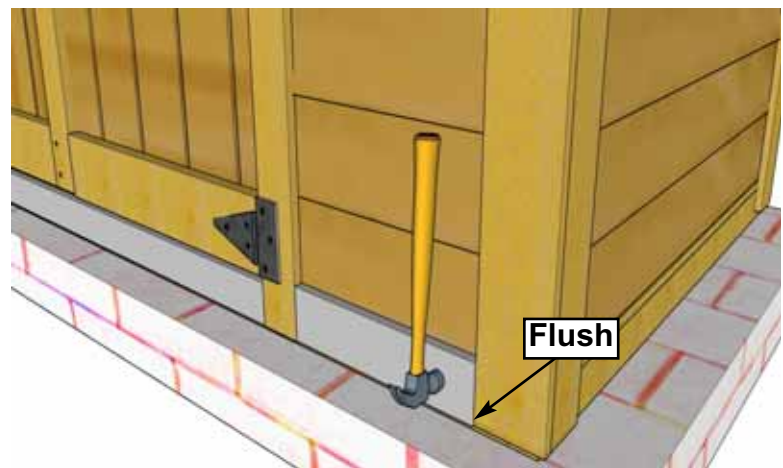
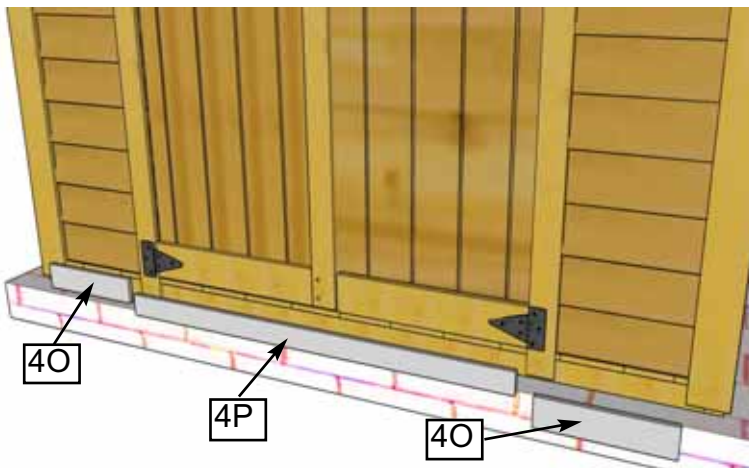

43. Locate both **Lower Front Narrow Trims (4O)** (1/2" x 2 1/2" x 11 1/8") and **Doorway Narrow Trim (4P)** (1/2" x 2" x 40 7/8"). Place narrow wall trims between door trim and front corner trim flush with bottom of trims. Attach each with 2 - 1 1/2" Finishing Nails. Place lower door trim between door trims flush with bottom. Attach with 4 - 1 1/2" Finishing Nails (K).



44. Attach **Door Handles (X)** to doors with 3 - 3/4" **Black Headed Screws (J)** per handle. Choose desired handle height. Make sure screws go into interior door framing and are not exposed on inside.



45. Attach **Black Barrel Bolt (W)** as illustrated above with 6 - 3/4" **Black Headed Screws (J)**.

Note: Female part of barrel bolt is positioned higher than male. Do a dry run first to position barrel bolt correctly.
Important - Drill pilot holes with 1/8" drill bit prior to securing with screws to prevent wood splitting.

Important: Drill shallow Pilot Holes to prevent splitting.

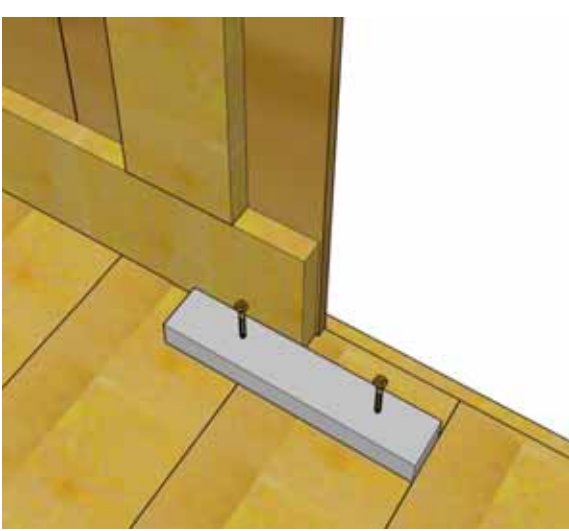

46. Attach **Lower Door Stop (4Q)** (3/4" x 1 1/2" x 8") to floor with **2 - 1 1/4" Screws (E)**. To align correctly, close door, mark, and attach. Drill pilot holes first to prevent wood from splitting.

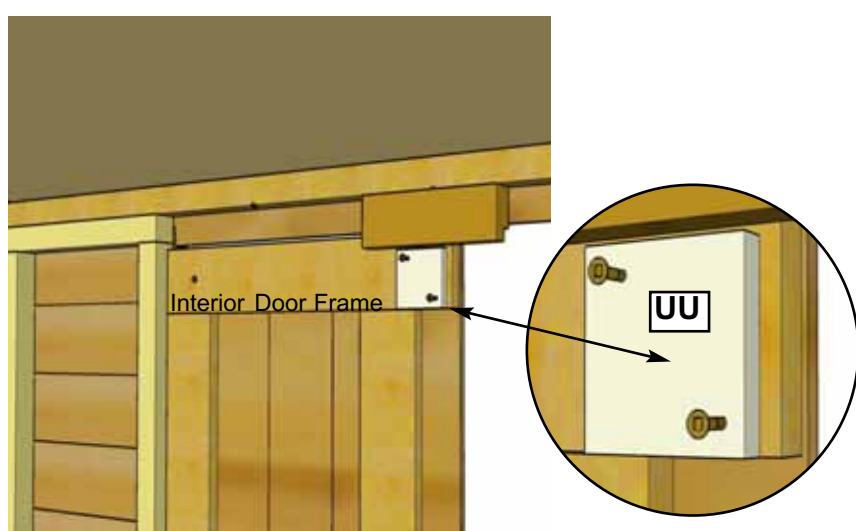

47. Install the **Barrel Bolt Plywood Spacer (UU)** to interior door frame, flush at the bottom, and 1/4" from edge, as pictured. Use **2 - 1 1/4" Screws (E)** to secure.

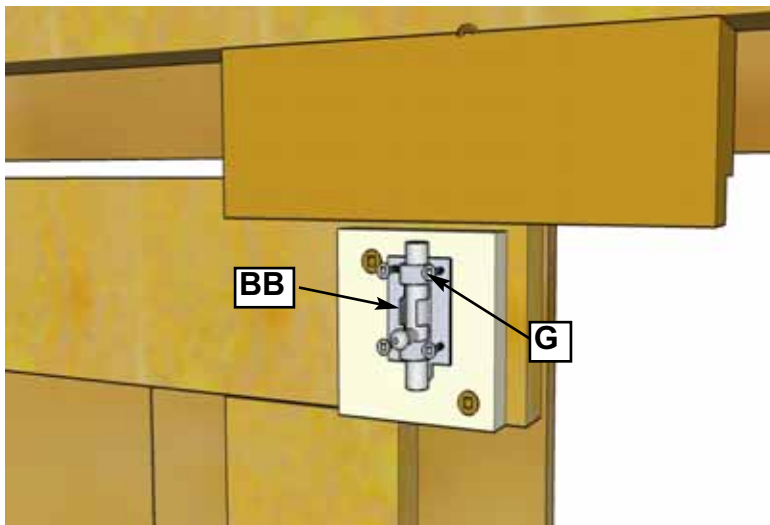

48. Position the **Interior Silver Barrel Bolt (BB)** on the plywood spacer and attach with **4 - 3/4" Silver Screws (G)**. Tap barrel bolt with hammer on underside of interior door stop to mark location.

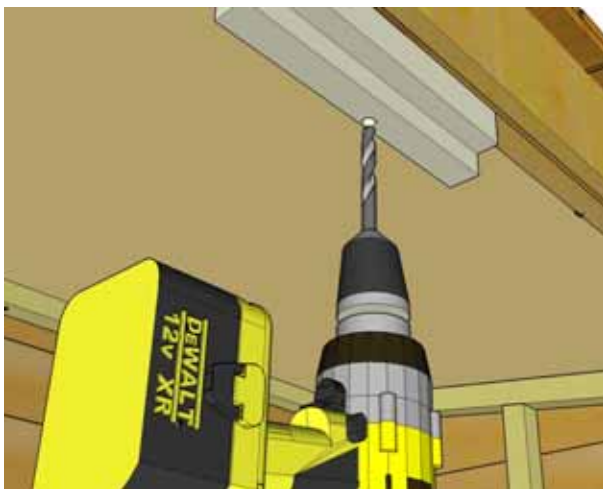
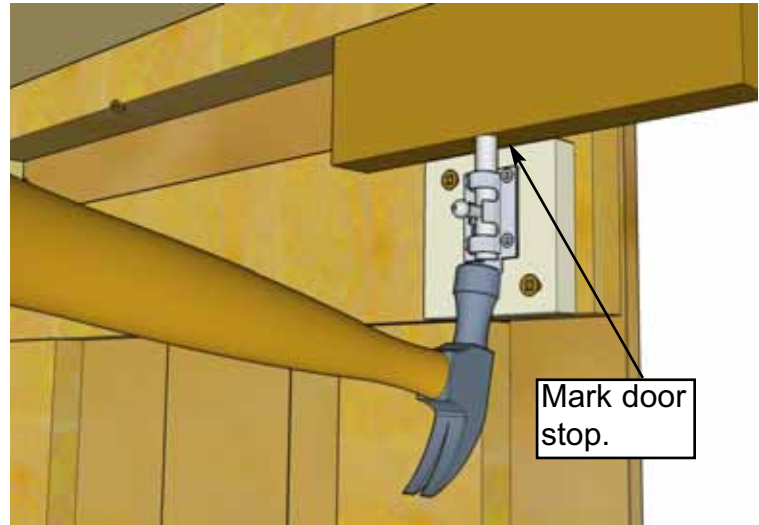

49. Open door and drill out marked barrel bolt impression with a 3/8" Drill Bit. Close door, slide barrel bolt in drilled hole to confirm fit.

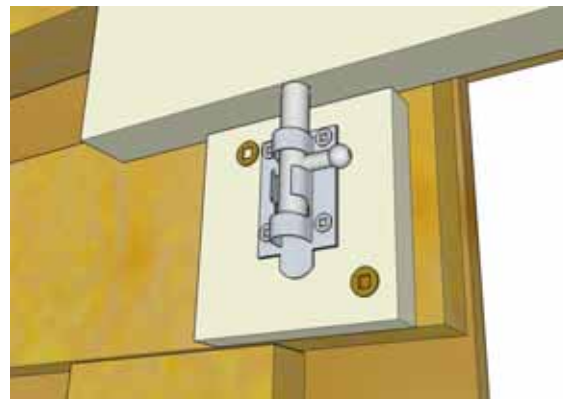



Note: Our Sheds are shipped as an unfinished product. If exposed to the elements, the Western Red Cedar lumber will weather to a silvery-gray color. If you prefer to keep the cedar lumber looking closer to the original color, we suggest that you treat the wood with a good oil base wood stain. You may also wish to paint your new shed rather than stain it. In both cases we recommend that you consult with a paint and stain dealer in your area for their recommendations.



Congratulations on assembling your 6x3 Grand Garden Chalet!

We hope your experience constructing our **6x3 Grand Garden Chalet** has been both positive and rewarding. We value your feedback and would like to hear back from you on how well we are doing in the following areas:

- 1. Customer Service**
- 2. On Time Shipping**
- 3. Motor Freight Delivery**
- 4. Quality of Materials**
- 5. Assembly Manual**
- 6. Overall Satisfaction.**



The materials contained in this Assembly Manual may be downloaded or copied provided that ALL copies retain the copyright and any other proprietary notices contained on the materials. No material may be modified, edited or taken out of context such that its use creates a false or misleading statement or impression as to the positions, statements or actions.

Please call, write or email us at:

Bearicuda Inc
3 West Street
Litchfield, CT 06759